



Sintesis air-cooled chillers

**Model RTAF 090 to 450
(300 to 1600 kW – 50 Hz)
Built for Industrial and Commercial Markets**



SINTECIS

RLC-PRC046D-GB

Introduction

The new Trane Sintesis model RTAF chiller is the result of a search for higher reliability, higher energy efficiency, and lower sound levels for today's environment.

In an effort to reduce energy consumed by HVAC equipment and to continually produce chilled water, Trane has developed the Model Sintesis chiller with higher efficiencies and a more reliable design than any other air-cooled chiller available on the market today.

The Sintesis model RTAF chiller uses the proven design of the Trane helical-rotary compressor, which embraces all of the design features that have made the Trane helical-rotary compressor liquid chillers such a success since 1987.

Trane Sintesis model RTAF chillers offers high reliability coupled with greatly improved energy efficiency, and improved acoustical performance, due to its advanced design, low-speed, direct-drive compressor, and proven Sintesis performance.

The major advantages of the Sintesis chiller are:

- 99.5% reliability rate
- Lower sound levels
- Higher energy efficiency at full load & part load.

The Sintesis model RTAF chiller is an industrial-grade design, built for both the industrial and commercial markets. It is ideal for schools, hotels, hospitals, retailers, office buildings, and industrial applications

Sintesis chillers are available in 3 sound levels and 5 efficiencies levels to answer accurately to every customer's needs.

Sound levels

- Standard Noise (SN)
- Low Noise (LN) (with or without Night Noise Setback (NNSB))
- Extra Low Noise (XLN)

Efficiency levels

- Standard Efficiency (SE)
- High Efficiency (HE)
- Extra Efficiency (XE)
- High Seasonal Efficiency (HSE)
- High Seasonal Efficiency Short (HSS)

Figure 1 – Model RTAF



Table of Contents

Introduction	2
Features and Benefits.....	4
Options	9
Application Considerations	12
General Data	15
Hydraulic module	37
Sound Power Levels	38
Controls System	39
TracerTU Interface	40
System Integration.....	41
Electrical Data	43
Dimensional Data	51
Mechanical Specifications	55

Features and Benefits

The Sintesis Helical-Rotary Compressor

- Unequaled-reliability. The Sintesis Trane helical-rotary compressor is designed, built, and tested to the same demanding and rugged standards as the Trane scroll compressors, the centrifugal compressors, and the previous generation helical-rotary compressors used in both air- and water-cooled chillers for more than 27 years.
- Years of research and testing. The Trane helical-rotary compressor has amassed thousands of hours of testing, much of it at severe operating conditions beyond normal commercial air-conditioning applications.
- Proven track record. The Trane Company is the world's largest manufacturer of large helical-rotary compressors used for refrigeration. Over 300,000 compressors worldwide have proven that the Trane helical-rotary compressor has a reliability rate of greater than 99.5% in the first year of operation — unequalled in the industry.
- Resistance to liquid slugging. The robust design of the Series R compressor can ingest amounts of liquid refrigerant that normally would severely damage compressor.
- Fewer moving parts. The helical-rotary compressor has only two rotating parts: the male rotor and the female rotor.

- Direct-drive, low-speed, semi-hermetic compressor for high efficiency and high reliability.
- Field-serviceable compressor for easy maintenance.
- Suction-gas-cooled motor. The motor operates at lower temperatures for longer motor life.
- Five minute start-to-start and two minute stop-to-start anti-recycle timer allows for closer water-loop temperature control.

Capacity Control and Load Matching

The combination patented unloading system on Trane helical-rotary compressors uses the variable unloading valve for the majority of the unloading function. This allows the compressor to modulate infinitely, to exactly match building load and to maintain chilled-water supply temperatures within $\pm 0.3^{\circ}\text{C}$ [$\pm 0.5^{\circ}\text{F}$] of the set point. Helical-rotary chillers that rely on stepped capacity control must run at a capacity equal to or greater than the load, and typically can only maintain water temperature to around $\pm 1^{\circ}\text{C}$ [$\pm 2^{\circ}\text{F}$]. Much of this excess capacity is lost because overcooling goes toward removing building latent heat, causing the building to be dried beyond normal comfort requirements.

On RTAF HSE version, the combination of the variable unloading valve plus the adaptive frequency drive allow to exactly match building load and get excellent efficiencies at full load and part load.

Figure 2 – Cutaway of a compressor

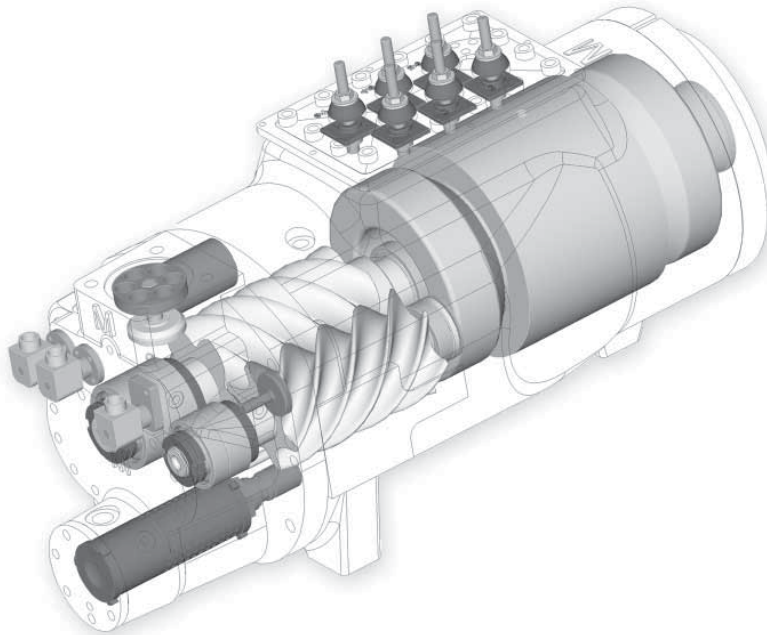

Features and Benefits

Close Spacing Installation

The Sintesis chiller has the tightest recommended side clearance in the industry, 1 meter, but that is not all. In situations where equipment must be installed with less clearance than recommended, which frequently occurs in retrofit applications, restricted airflow is common. Conventional chillers may not work at all. However, the Sintesis chiller with the Adaptive Control™ microprocessor will make as much chilled water as possible given the actual installed conditions, stay on-line during any unforeseen abnormal conditions, and optimize its performance. Consult your sales engineer for more details.

Factory Testing Means Trouble-Free Start-up

All Sintesis chillers are given a complete functional test at the factory. This computer-based test program completely checks the sensors, wiring, electrical components, microprocessor function, communication capability, expansion valve performance, and fans. In addition, each compressor is run-tested to verify capacity and efficiency. Where applicable, each unit is factory preset to the customer's design conditions. An example would be the leaving-liquid temperature set point. The result of this test program is that the chiller arrives at the job site fully tested and ready for operation.

Factory-Installed and Tested Controls and Options Speed Installation

All Sintesis chiller options, including low ambient control, ambient temperature sensor, low ambient lockout, communication interface and ice-making controls are factory installed and tested. Some manufacturers send accessories in pieces to be field installed. With Trane, the customer saves on installation expense and has assurance that ALL chiller controls and options have been tested and will function as expected.

Micro channel condensing coils

Sintesis chillers are equipped with micro channel condensing coils allowing excellent heat transfer and a dramatic improvement of corrosion resistance versus conventional tubes in fins coils. Micro channel coils are 100% aluminum and galvanic corrosion which can occur on condensers made with copper tubes and aluminum fins is avoided. Micro channel coils are also well adapted to dirty environments thanks their small thickness and fins profile.

Figure 3 – Micro channel condensing coils

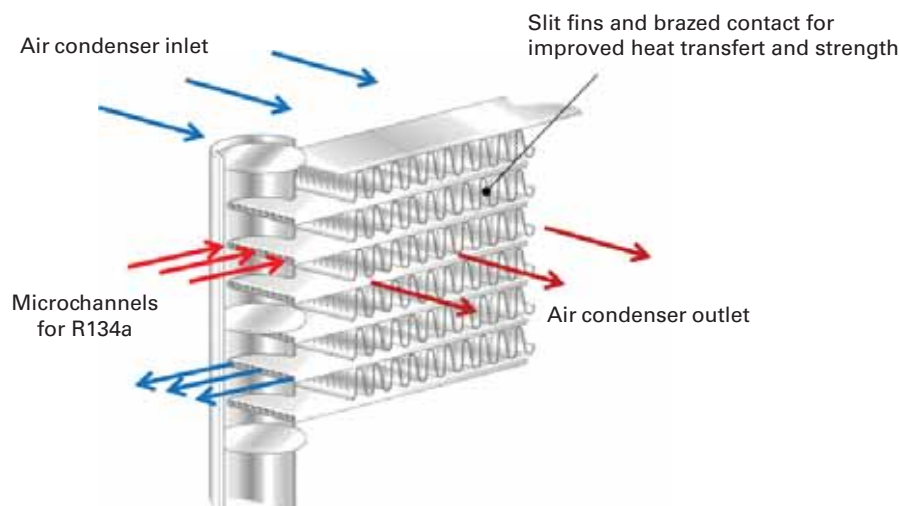

Features and Benefits

CHIL evaporator

Trane developed an evaporator specially designed for Sintesis chillers. Compact - High performance - Integrated design - Low charge (CHIL) evaporator optimizes the flow of the refrigerant to get an excellent heat exchange with water in every operating condition and minimize the quantity of refrigerant used.

Figure 4 – CHIL Evaporator

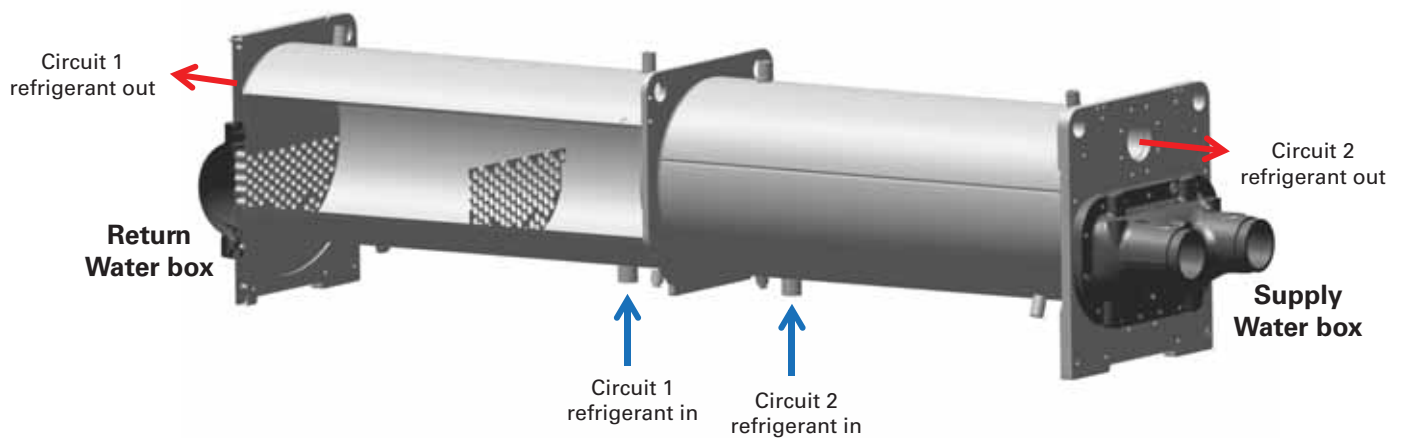

Fans

Most of Sintesis chillers use EC fans in order to reduce power consumption at full load and at part load. EC fans allow a significant reduction of sound level and a better operation of the chiller at low ambient conditions. On XLN units EC fans are equipped with a diffuser to get an air flow optimization and a quieter operation.

Figure 5 – EC fan with diffuser



Features and Benefits

Figure 6 – Ice storage demand cost savings

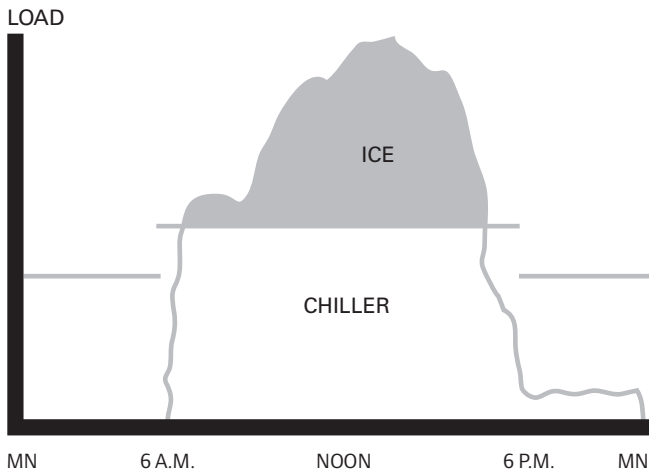

Superior Control with UC 800™ Chiller Controls

The Adaptive Control™ microprocessor system enhances the Sintesis chiller by providing the very latest chiller control technology. With the Adaptive Control microprocessor, unnecessary service calls and unhappy tenants are avoided. The unit does not nuisance-trip or unnecessarily shut down. Only when the Tracer chiller controls have exhausted all possible corrective actions and the unit is still violating an operating limit, will the chiller shut down. Controls on other equipment typically shut down the chiller, usually just when it is needed the most.

For Example:

A typical five-year-old chiller with dirty coils might trip out on high-pressure cutout on a 38°C [100°F] day in August. A hot day is just when comfort cooling is needed the most. In contrast, the Sintesis chiller with an Adaptive Control microprocessor will stage fans on, modulate the electronic expansion valve, and modulate the slide valve as it approaches a high-pressure cutout, thereby keeping the chiller on line when you need it the most, on high ambient temperatures.

System Options:

Ice Storage

Trane air-cooled chillers are well-suited for ice production. The unique ability to operate at decreased ambient temperature while producing ice results in approximately the same amount of work for the compressor. An air-cooled machine typically switches to ice production at night. Two things happen under this assumption. First, the leaving brine temperature from the evaporator is lowered to around -5.5 to -5°C [22 to 24°F]. Second, the ambient temperature has typically dropped about 8.3 to 11°C [47 to 52°F] from the peak daytime ambient. This effectively places a lift on the compressors that is similar to daytime running conditions. The chiller can operate in lower ambient at night and successfully produce ice to supplement the next day's cooling demands.

The Model RTAF produces ice by supplying ice storage tanks with a constant supply of glycol solution.

Air-cooled chillers selected for these lower leaving-fluid temperatures are also selected for efficient production of chilled fluid at nominal comfort-cooling conditions. The ability of Trane chillers to serve "double duty" in ice production and comfort cooling greatly reduces the capital cost of ice-storage systems.

When cooling is required, ice-chilled glycol is pumped from the ice storage tanks directly to the cooling coils. No expensive heat exchanger is required. The glycol loop is a sealed system, eliminating expensive annual chemical treatment costs. The air-cooled chiller is also available for comfort-cooling duty at nominal cooling conditions and efficiencies. The modular concept of glycol ice-storage systems, and the proven simplicity of Trane Tracer™ controls, allows the successful blend of reliability and energy-saving performance in any ice-storage application.

The ice-storage system is operated in six different modes, each optimized for the utility cost at a particular time of day.

1. Provide comfort cooling with chiller
2. Provide comfort cooling with ice
3. Provide comfort cooling with ice and chiller
4. Freeze ice storage
5. Freeze ice storage when comfort cooling is required
6. Off.



Features and Benefits

UC 800 optimization software controls operation of the required equipment and accessories to easily move from one mode of operation to another. For example: even with ice-storage systems, there are numerous hours when ice is neither produced nor consumed, but saved. In this mode, the chiller is the sole source of cooling. For example, to cool the building after all ice is produced but before high electrical demand charges take effect, UC 800 sets the air-cooled chiller leaving fluid set point to its most efficient setting and starts the chiller, chiller pump, and load pump.

When electrical demand is high, the ice pump is started and the chiller is either demand limited or shut down completely. UC 800 controls have the intelligence to optimally balance the contribution of the ice and the chiller in meeting the cooling load. The capacity of the chiller plant is extended by operating the chiller and ice in tandem. UC 800 rations the ice, augmenting chiller capacity while reducing cooling costs. When ice is produced, UC 800 will lower the air-cooled chiller leaving-fluid set point and start the chiller, ice and chiller pumps, and other accessories. Any incidental loads that persist while producing ice can be addressed by starting the load pump and drawing spent cooling fluid from the ice storage tanks.

For specific information on ice storage applications, contact your local sales office.

Application options

Ice making

The ice making option provides special control logic to handle low temperature brine applications (less than 4.4°C [40°F] leaving evaporator temperature) for thermal storage applications.

Low temperature brine

Low temperature option provides special control logic and oil cooler is installed to handle low temperature brine applications including part load conditions below 4.4°C (40°F) leaving evaporator temperature.

Low ambient

The low ambient option adds unit controls to allow start and operation when the unit works with ambient temperatures between -10°C (14°F) and -20°C (-4°F). High side of ambient range remains at 46°C (115°F).

High ambient

The high ambient option adds unit controls, oil coolers and oversized electrical components to allow start and operation up to ambient temperatures of 55°C (131°F) operation. Low side of ambient range remains at -10°C (14°F).

SmartFlow Control

Constant speed pump – Variable frequency drive adjustment

The unit is equipped with a pump package driven by a speed inverter, without providing continuous modulation of the speed. The water flow is fixed during commissioning. The goal of this alternative is to provide the appropriate flow rate and hydraulic balance, without the need for a mechanical balancing valve, and by taking advantage of the energy consumption optimization of the pump.

Water flow is adjusted through parameter 204 of the speed inverter (TR200), when having the dual pump option, the active pump arbitration is based on pump equalization time and pump failure status.

Variable speed pump – Constant differential pressure (DP)

The unit is equipped with a pump package driven by a speed inverter. The modulation of the pump speed is made in order to ensure that the Differential Pressure (DP) remains constant within the system. The minimum pump speed is factory set at 60% of the nominal speed. The minimum pump frequency can be adjusted through inverter. The constant DP option is intended to be used with 2-way water regulation valves in the customer hydraulic system. At minimum system partial load, when most of the 2-way valves are closed, a minimum flow rate must be ensured through the chiller evaporator. DP is measured by a differential pressure sensor supplied by Trane, that the customer must install on the water loop, in a freeze protected area. A regulation valve should be installed on the by-pass line.

Variable speed pump – Constant differential temperature (DT)

The unit will be equipped with a pump package driven by a speed inverter. The modulation of the pump speed is managed to ensure that chiller DT stays constant. Entering and leaving temperatures at the evaporator will be measured directly by the chiller controller, through the factory-supplied sensor. A DT setpoint will be present on the unit controller. The option for constant DT is intended to be used with 3-way valves on water systems, or 2-way valves on water system but constant flow at the by-pass. The minimum pump frequency can be adjusted on the inverter.

Partial and Total Heat Recovery

Heat recovery appears more and more as a sensible response to offset energy costs continually on the rise. The Trane Sintesis chillers with Partial and Total Heat Recovery option combines the energy savings of heat recovery operation with the installation and maintenance cost savings of completely factory packaged air cooled liquid chillers. The RTAF with Heat Recovery option operate as a standard chiller as long as heat is not required or it can simultaneously produce chilled and hot water which can be used for applications like: Heating or preheating of boiler systems or domestic cater, Air conditioning/ventilation air pre-heat, and Industrial processes.

The Heat Recovery Exchanger is a brazed plate exchanger, connected to the compressor discharge line, and sized to recover up to 25% of the nominal cooling capacity for PHR and 135% of the nominal cooling capacity for THR.

The Heat Recovery Exchanger is not approved for Food and Beverage applications. The use of a primary loop is mandatory.

The amount of net heat recovery depends on:

- the percentage of cooling load available
- the ambient temperature

Direct and Glycol Free Free-cooling

In order to take advantage of the low ambient temperatures, Sintesis chillers propose four alternatives, of free cooling:

- Total Direct Free-cooling
- Partial Direct Free-cooling
- Total Glycol free Free-cooling
- Partial Glycol free Free-cooling

The advantages of this type of application are:

- A small footprint compared to a system where a dry cooler and a chiller are used
- One single equipment control
- A wide range of capacities

The Sintesis Series, RTAF Free Cooling are designed for countries that have a significant yearly number of hours below 0 °C and for applications where cooling is needed year round.



Options

Sound level options

Low noise

Low noise units are equipped with a jacket on the oil separators and a pre-formed 'sound box' encapsulating each compressor.

Low noise with NNSB

Night noise set back allow to reduce the sound level of the chiller by reducing the speed of EC fans controlled with an external on/off contact.

Extra low noise

Extra low noise units are equipped with a jacket on the oil separators, a pre-formed 'sound box' encapsulating each compressor and EC fans with diffusers.

Electrical options

Under over voltage protection IP20 internal protection. Flow switch: the flow switch is sent as an accessory and has to be installed on site.

Hydraulic module option*

Hydraulic module includes the following components: water strainer, expansion vessel 80l, pressure relief valve set at 5 bars, twin pump low head allowing a pressure drop in the water circuit up to 120kPa or twin pump high head allowing a pressure drop in the water circuit up to 220kPa, balancing valve and anti-freeze protection.

Control options

BACnet™ communications interface

Allows the user to easily interface with BACnet via a single twisted pair wiring to a factory installed and tested communication board.

LonTalk™ (LCI-C) Communications Interface

Provides the LonMar chiller profile inputs/outputs for use with a generic building automation system via a single twisted pair wiring to a factory installed and tested communication board.

ModBus™ Communications Interface

Allows the user to easily interface with ModBus via a single twisted pair wiring to a factory installed and tested communication board.

External chilled water setpoint

UC800 accepts either a 2-10 VDC or a 4-20mA input signal, to adjust the chilled water setpoint from a remote location.

External current limit setpoint

UC800 accepts either a 2-10VDC or a 4-20mA input signal to adjust the current limit setpoint from a remote location.

Ice making contact

UC800 provides an output contact closure that can be used as a signal to the system that ice building is in operation. This relay will be closed when ice building is in progress and open when ice building has been terminated by either UC800 or the remote interlock. It is used to signal the system changes required to convert to and from ice making.

Run test report

Run test report gives the results of the performance test of the unit in the design conditions specified in the order write up with water without glycol.

The data recorded are: cooling capacity, power input, air temperature, water entering temperature, water leaving temperature and water flow.

* Components may differ depending on unit model and size. Contact your local sales office for details.

Other Options

Relief valves

Dual relief valve plus 3 way valve on high pressure side.

High performance insulation

Evaporator is insulated with 2 layers of Armaflex II or equivalent of 19 mm (3/4 inches) thickness and K factor of 0,26 W/m²K.

Evaporator without insulation

Evaporator is not insulated and a specific insulation can be done on site.

Coated condensing coils

Condensing coils are protected with a cathodic epoxy electro deposition coating UV resistant.

Neoprene pads

Neoprene pads avoid a direct contact of the base of the unit with the ground.

Neoprene isolators

Isolators provide isolation between chiller and structure to help eliminate vibration transmission and have an efficiency of 95% minimum.

Grooved pipe plus weld coupling

Grooved pipes are connected on water inlet and outlet, the cooling allows the connection between the grooved pipe and the evaporator water connection.

Export shipping package

Metallic clog are fixed on the base frame of the unit. It prevents direct contact between the chiller and the container while loading and unloading from the container.

Disconnect with circuit breaker

The unit is equipped with a circuit breaker for each circuit and a centralized connecting block for the 3 phases.

Operating Map

To choose the unit configuration, refer to operating map figure below: Standard ambient, High ambient or Low ambient.

* Standard ambient units:

$$-10^{\circ}\text{C} \leq \text{Air temperature} \leq 46^{\circ}\text{C}.$$

* Low ambient units:

$$-20^{\circ}\text{C} \leq \text{Air temperature} \leq 46^{\circ}\text{C}$$

* High ambient units:

$$-10^{\circ}\text{C} \leq \text{Air temperature} \leq 55^{\circ}\text{C}$$

Note: It is not possible to have a unit operate low and high ambient.

Figure 7 – RTAF Operating Map

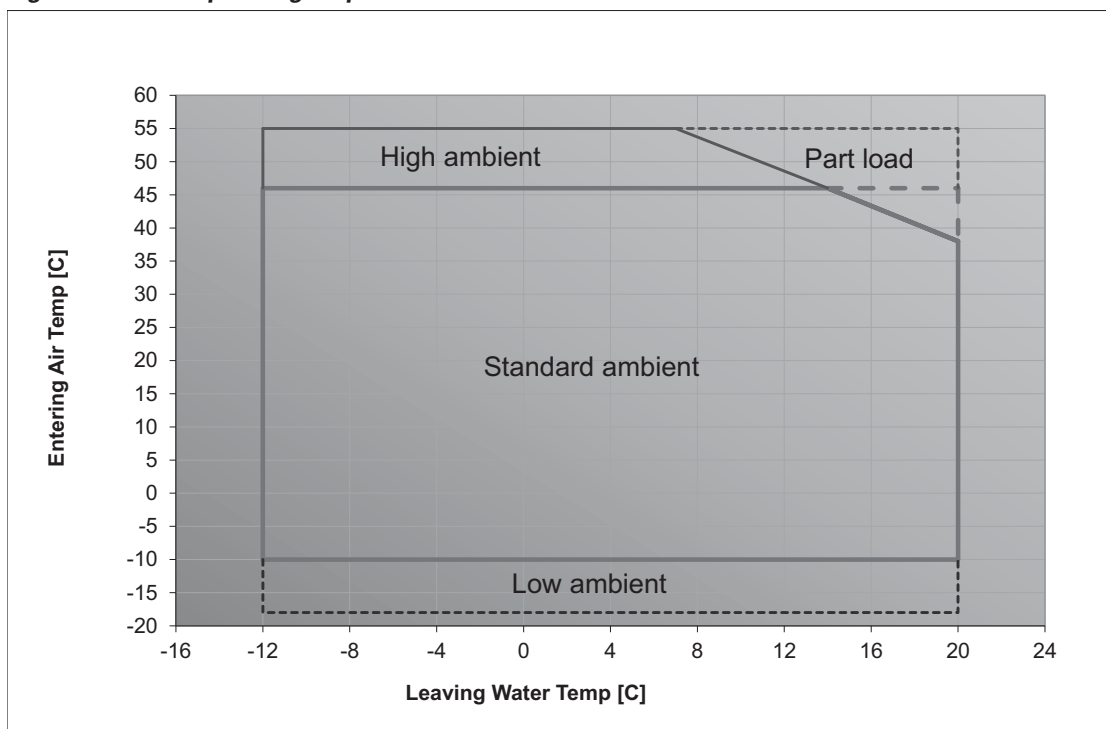

Application Considerations

Figure 8 – Flow rate Out of Range

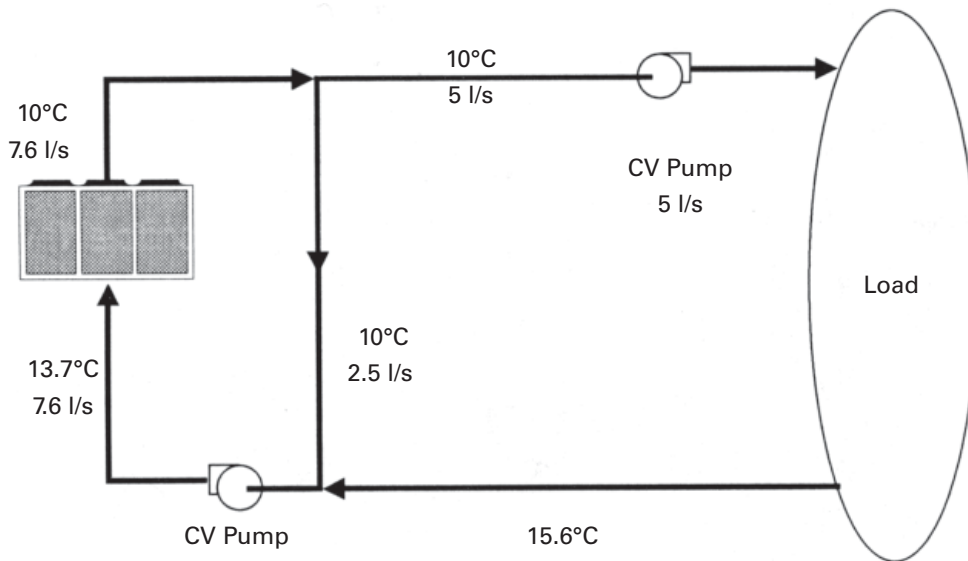

Important

Certain application constraints should be considered when sizing, selecting, and installing Trane Sintesis chillers. Unit and system reliability is often dependent on properly and completely complying with these considerations. When the application varies from the guidelines presented, it should be reviewed with your local sales engineer.

Unit Sizing

Unit capacities are listed in the performance data section. Intentionally oversizing a unit to ensure adequate capacity is not recommended. Erratic system operation and excessive compressor cycling are often a direct result of an oversized chiller. In addition, an oversized unit is usually more expensive to purchase, install, and operate. If oversizing is desired, consider using two units.

Water Treatment

Dirt, scale, products of corrosion, and other foreign material will adversely affect heat transfer between the water and system components. Foreign matter in the chilled-water system can also increase pressure drop and, consequently, reduce water flow. Proper water treatment must be determined locally, depending on the type of system and local water characteristics. Neither salt nor brackish water is recommended for use in Trane Sintesis chillers. Use of either will lead to a shortened chiller life. Trane encourages the employment of a reputable water-treatment specialist, familiar with local water conditions, to assist in this determination and in the establishment of a proper water-treatment program.

Effect of Altitude on Capacity

Sintesis chiller capacities given in the performance data tables are for use at sea level. At elevations substantially above sea level, the decreased air density will reduce condenser capacity and, therefore, unit capacity and efficiency.

Ambient Limitations

Trane Sintesis chillers are designed for year-round operation over a range of ambient temperatures. The Sintesis chiller will operate in ambient temperatures of -10 to 46°C [14 to 115°F]. Selecting the high-ambient option will allow the chiller to operate in ambient temperatures of 55°C [131°F], and selecting the low-ambient option will increase the operational capability of the water chiller to ambient temperatures as low as -20°C [-4°F]. For operation outside of these ranges, contact the local sales office.

Water Flow Limits

The minimum water flow rates are given in Tables 1 to 6. Evaporator flow rates below the tabulated values will result in laminar flow and cause freeze-up problems, scaling, stratification, and poor control.

The maximum evaporator water flow rate is also given in the general data section. Flow rates exceeding those listed may result in excessive tube erosion.

Flow Rates Out of Range

Many process cooling jobs require flow rates that cannot be met with the minimum and maximum published values within the Model Sintesis evaporator. A simple piping change can alleviate this problem. For example: a plastic injection molding process requires 5.0 l/s [80 gpm] of 10°C [50°F] water and returns that water at 15.6°C [60°F]. The selected chiller can operate at these temperatures, but has a minimum flow rate of 7.6 l/s [120 gpm]. The following system can satisfy the process.

Application Considerations

Flow Control

Trane requires the chilled water flow control in conjunction with the Sintesis Chiller to be done by the chiller.

This will allow the chiller to protect itself in potentially harmful conditions.

Leaving-Water Temperature Limits

Trane air-cooled Sintesis Series chillers have three distinct leaving-water categories: standard, low temperature, and ice making. The standard leaving-solution temperature range is 4.4 to 18°C [40 to 65°F]. Low-temperature machines produce leaving-liquid temperatures less than 4.4°C [40°F]. Since liquid supply temperature set points less than 4.4°C [40°F] result in suction temperatures at or below the freezing point of water, a glycol solution is required for all low-temperature machines. Ice-making machines have a leaving-liquid temperature range of -12 to 20°C [10.5 to 68°F]. Ice-making controls include dual set point controls and safeties for ice making and comfort cooling capabilities. Consult your local sales engineer for applications or selections involving low temperature or ice making machines. The maximum water temperature that can be circulated through an evaporator when the unit is not operating is 55°C [131°F].

Leaving-Water Temperature

Out of Range

Many process cooling jobs require temperature ranges that cannot be met with the minimum and maximum published values for the RTAF evaporator. A simple piping change can alleviate this problem. For example: a laboratory load requires 7.6 l/s [120 gpm] of water entering the process at 29.4°C [85°F] and returning at 35°C [95°F]. The accuracy required is higher than the cooling tower can give. The selected chiller has adequate capacity, but has a maximum leaving-chilled-water temperature of 18°C [64°F]. In the example shown, both the chiller and process flow rates are equal. This is not necessary. For example, if the chiller had a higher flow rate, there would be more water bypassing and mixing with warm water.

Supply-Water Temperature Drop

The performance data for the Trane Sintesis chiller is based on a chilled-water temperature drop of 6°C [43°F]. Chilled-water temperature drops from 3.3 to 10°C [38 to 50°F] may be used as long as minimum and maximum water temperature, and minimum and maximum flow rates, is not violated. Temperature drops outside this range are beyond the optimum range for control, and may adversely affect the microcomputer's ability to maintain an acceptable supply-water temperature range. Further, temperature drops of less than 3.3°C [38°F] may result in inadequate refrigerant superheat. Sufficient superheat is always a primary concern in any direct-expansion refrigerant system and is especially important in a package chiller where the evaporator is closely coupled to the compressor. When temperature drops are less than 3.3°C [38°F], an evaporator runaround loop may be required.

Figure 9 – Flow rate Out of Range

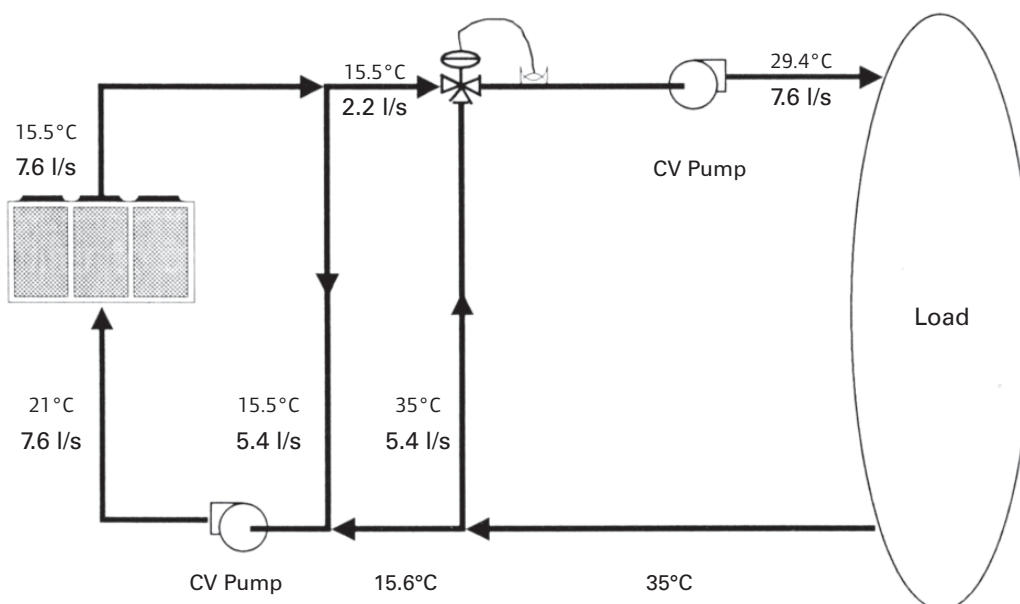



Application Considerations

Ice Storage Provides

Reduced Electrical Demand an ice-storage system uses a standard chiller to make ice at night, when utilities charge less for electricity. The ice supplements, or even replaces, mechanical cooling during the day, when utility rates are at their highest. This reduced need for cooling results in big utility cost savings.

Another advantage of ice storage is standby cooling capacity. If the chiller is unable to operate, one or two days of ice may still be available to provide cooling. In that period of time, the chiller can be repaired before building occupants feel any loss of comfort.

The Trane Sintesis Model RTAF chiller is uniquely suited to low-temperature applications like ice storage because of the ambient relief experienced at night. This allows the Model Sintesis chiller to produce ice efficiently, with less stress on the machine.

Simple and smart control strategies are another advantage the Model Sintesis chiller offers for ice-storage applications. Trane UC 800 building management systems can actually anticipate how much ice needs to be made at night, and operate the system accordingly. The controls are integrated right into the chiller. Two wires and preprogrammed software dramatically reduce field installation cost and complex programming.

Short Water Loops

The proper location of the temperature control sensor is in the supply (outlet) water connection or pipe.

This location allows the building to act as a buffer and assures a slowly-changing return- water temperature. If there is not a sufficient volume of water in the system to provide an adequate buffer, temperature control can be lost, resulting in erratic system operation and excessive compressor cycling. A short water loop has the same effect as attempting to control using the building return water. Typically, a two-minute water loop is sufficient to prevent a short water loop. Therefore, as a guideline, ensure that the volume of water in the evaporator loop equals or exceeds two times the evaporator flow rate per minute. For a rapidly changing load profile, the amount of volume should be increased. To prevent the effect of a short water loop, the following item should be given careful consideration: a storage tank or larger header pipe to increase the volume of water in the system and, therefore, reduce the rate of change of the return water temperature.

Application Types

- Comfort cooling
- Industrial process cooling
- Ice or thermal storage
- Low-temperature process cooling.

General Data

Table 1 – General Data RTAF 090 – 205 Standard Efficiency - Standard and Low Noise

RTAF Standard Efficiency - Standard and Low Noise		RTAF 090	RTAF 105	RTAF 125	RTAF 145	RTAF 155	RTAF 175	RTAF 190	RTAF 205
Eurovent Performances		SE SN&LN	SE SN&LN	SE SN&LN	SE SN&LN	SE SN&LN	SE SN&LN	SE SN&LN	SE SN&LN
Net Cooling Capacity (3) (4)	(kW)	326.1	375.4	440	521.8	563.7	615.2	675.4	731.5
Power Input (5)	(kW)	103.8	121.2	145.5	165.3	184.3	206.4	221.1	243.7
EER (3) (4) (6)	(kW/kW)	3.14	3.1	3.02	3.16	3.06	2.98	3.05	3
ESEER (6)	(kW/kW)	3.79	3.79	3.85	3.83	3.77	3.88	3.83	3.83
Eurovent Efficiency class Cooling		A	B	B	A	B	B	B	B
Sound power level (Standard Noise) (10)	(dBA)	95	95	95	96	96	97	97	97
Sound power level (Low Noise) (10)	(dBA)	92	92	92	93	93	94	94	94
Middle East design condition performances (7)									
Gross cooling capacity	(tons)	271	310	362	435	467	509	561	606
Gross EER	(kW/ton)	2.36	2.3	2.24	2.36	2.27	2.21	2.28	2.23
Compressor									
Quantity	#	2	2	2	2	2	2	2	2
Nominal Size (1)	tons	45/45	50/50	70/50	70/70	85/70	100/70	100/85	100/100
Evaporator									
Evaporator Model		115B	115A	165B	165B	165A	200B	200B	250C
Water Storage	l	51	58	74	74	78	99	99	109
Two pass Evaporator									
Minimum Flow	l/s	8.0	9.4	11.6	11.6	12.4	14.2	14.2	16.2
Maximum Flow	l/s	29.6	34.7	43.1	43.1	46.0	52.6	52.6	60.3
Two pass Evaporator – With Turbulators									
Minimum Flow	l/s	6.6	7.8	9.7	9.7	10.3	11.8	11.8	13.5
Maximum Flow	l/s	26.6	31.2	38.7	38.7	41.3	47.2	47.2	54.1
Condenser									
Quantity of Coils	#	4/4	4/4	4/4	5/5	5/5	6/4	6/6	6/6
Coil Length	mm	1967	1967	1967	1967	1967	1967	1967	1967
Coil Height	mm	1214	1214	1214	1214	1214	1214	1214	1214
Condenser Fans									
Quantity (1)	#	4/4	4/4	4/4	5/5	5/5	6/4	6/6	6/6
Diameter	mm	800	800	800	800	800	800	800	800
Air flow per Fan	m ³ /s	5.6	5.6	5.6	5.6	5.6	5.6	5.6	5.6
Nominal RPM	rpm	932	932	932	932	932	932	932	932
Motor	kW	1.4	1.4	1.4	1.4	1.4	1.4	1.4	1.4
Minimum Starting/Operating Ambient									
Standard Unit	°C	-10	-10	-10	-10	-10	-10	-10	-10
Low-Ambient Unit (Option)	°C	-20	-20	-20	-20	-20	-20	-20	-20
Maximum ambient operation Standard ambient (9)	°C	46	46	46	46	46	46	46	46
Maximum ambient operation High ambient (9)	°C	55	55	55	55	55	55	55	55
General Unit									
Refrigerant		HFC134a	HFC134a	HFC134a	HFC134a	HFC134a	HFC134a	HFC134a	HFC134a
Number of Independent Refrigerant Circuits	#	2	2	2	2	2	2	2	2
Minimum Load (2)	%	15	15	15	15	15	15	15	15
Operating Weight	kg	3295	3330	3510	3970	4240	4400	4820	4845
Shipping Weight	kg	3240	3265	3425	3885	4150	4285	4705	4720

Notes:

1. Data containing information on two circuits shown as follows: ckt1/ckt2
2. Percent minimum load is for total machine at 10°C (50°F) ambient and 7°C (44°F) leaving chilled water temperature, not each individual circuit.
3. Net cooling capacity at Eurovent conditions, 7°C leaving water temperature and 35°C entering condenser air temperature.
4. Ratings based on sea level altitude and evaporator fouling factor 0.017645 m²K/kW
5. Unit kW input, including fans
6. Calculate with cooling capacity
7. At Evaporator water temperature: 6.6°C (44°F) / 12.2°C (54°F) - Condenser air temperature 46°C (114.8°F)
9. Maximum ambient operation is for unit at 12°C / 7°C
10. At Eurovent conditions, with 1pW Reference Sound Power, according to ISO9614

General Data

Table 2 – General Data RTAF 250-410 Standard Efficiency - Standard and Low Noise

		RTAF 250	RTAF 280	RTAF 310	RTAF 350	RTAF 380	RTAF 410
		SE-SN & LN	SE-SN & LN	SE-SN & LN	SE-SN & LN	SE-SN & LN	SE-SN & LN
Eurovent Performances (1)							
Net Cooling Capacity	(kW)	859	972	1074	1194	1322	1446
Total Power input in cooling	(kW)	290	329	376	419	457	497
EER		2.97	2.96	2.86	2.85	2.89	2.91
ESEER		3.94	3.91	3.9	3.99	4.06	4.09
Eurovent Efficiency class Cooling		B	B	C	C	C	B
Sound power level (Standard Noise)	(dBA)	99	100	101	101	101	102
Sound power level (Low Noise)	(dBA)	96	97	98	98	98	99
Middle East design condition performances (2)							
Gross cooling capacity	(kW)	713	808	890	964	1074	1179
Gross EER		2.2	2.2	2.12	2.06	2.1	2.12
Compressor							
Quantity	#	3	3	3	4	4	4
Model		85-85/70	85-100/85	100-100/100	85-85/85-85	85-100/85-100	100-100/100-100
Evaporator							
Evaporator model		300D	300B	300A	500D	500C	500B
Evaporator Water Content volume	(l)	97	108	120	146	159	170
One pass evaporator							
Evap. Water Flow rate - Minimum	(l/s)	17.7	20.1	22.8	25.0	27.8	30.3
Evap. Water Flow rate - Maximum	(l/s)	65.8	74.5	84.8	92.8	103.0	112.5
One pass with turbulator evaporator							
Evap. Water Flow rate - Minimum	(l/s)	14.8	16.7	19.0	20.8	23.1	25.3
Evap. Water Flow rate - Maximum	(l/s)	59.1	66.9	76.1	83.4	92.5	101.1
Condenser							
Quantity	#	10/4	10/6	10/6	10/8	10/10	12/10
Face area per coil	(m ²)	2.4	2.4	2.4	2.4	2.4	2.4
Condenser Fan							
Quantity	#	10/4	10/6	10/6	10/8	10/10	12/10
Diameter	(mm)	800	800	800	800	800	800
Standard / High ambient fan option							
Fan / motor Type		Propeller fan / Fixed speed - AC motor					
Airflow per Fan	(m ³ /s)	5.6	5.6	5.6	5.6	5.6	5.6
Rated motor RPM	(rpm)	932	932	932	932	932	932
Low ambient fan option							
Fan / motor Type		Propeller fan / Variable speed - EC motor					
Airflow per Fan	(m ³ /s)	5.6	5.6	5.6	5.6	5.6	5.6
Rated motor RPM	(rpm)	910	910	910	910	910	910
Operating limits							
Minimum Starting / Operating Ambient (7)							
Standard ambient unit	(°C)	-10	-10	-10	-10	-10	-10
Low Ambient (Option)	(°C)	-20	-20	-20	-20	-20	-20
Maximum ambient operation Standard ambient (8)	(°C)	46	46	46	46	46	46
Maximum ambient operation High ambient (8)	(°C)	55	55	55	55	55	55
System data							
Nb of refrigerant circuit	#	2	2	2	2	2	2
Minimum cooling load % (6)	%	15	15	15	15	15	15
Shipping Weight(5)	(kg)	6430	6965	6980	8370	8735	9085
Operating Weight(5)	(kg)	6485	7025	7070	8460	8830	9185

Notes:

- (1) At Evaporator water temperature: 12°C / 7°C - Condenser air temperature 35°C according to EN14511:2013
- (2) At Evaporator water temperature: 6.6°C (44°F) / 12.2°C (54°F) - condenser air temperature 46°C (114.8°F) - FFE=1.76*10⁻⁵ m²•°C/W
- (4) Under 400V/3/50Hz
- (5) Rated Condition without Pump Package
- (6) Percent minimum load can be lowered on demand to local sales office
- (7) Minimum start-up/operation ambient based on a 2.22 m/s (5mph) wind across the condenser
- (8) Maximum ambient operation is for unit at 12°C / 7°C
- (10) At Eurovent conditios, with 1pW Reference Sound Power, according ISO9614

Electrical & system data are subject to change without notice. Please refer to unit nameplate data

General Data

Table 3 – General Data RTAF 090 – 205 Standard Efficiency - Extra Low Noise

RTAF Standard Efficiency - Extra Low Noise		RTAF 090	RTAF 105	RTAF 125	RTAF 145	RTAF 155	RTAF 175	RTAF 190	RTAF 205
Eurovent Performances		SE XLN	SE XLN	SE XLN	SE XLN	SE XLN	SE XLN	SE XLN	SE XLN
Net Cooling Capacity (3) (4)	(kW)	326.3	375.6	440.3	522.2	564.2	615.8	676	732.1
Power Input (5)	(kW)	101.2	118.6	142.9	162	181	203.1	217.1	239.7
EER (3) (4) (6)	(kW/kW)	3.23	3.17	3.08	3.22	3.12	3.03	3.11	3.05
ESEER (6)	(kW/kW)	4.13	4.07	4.06	4.12	4.02	4.08	4.04	4.01
Eurovent Efficiency class Cooling		A	A	B	A	A	B	A	B
Sound power level (Extra Low Noise) (10)	(dBA)	88	89	89	89	90	90	91	91
Middle East design condition performances (7)									
Gross cooling capacity	(tons)	271	310	363	435	467	509	561	606
Gross EER	(kW/ton)	2.41	2.35	2.28	2.41	2.31	2.25	2.32	2.27
Compressor									
Quantity	#	2	2	2	2	2	2	2	2
Nominal Size (1)	tons	45/45	50/50	70/50	70/70	85/70	100/70	100/85	100/100
Evaporator									
Evaporator Model		115B	115A	165B	165B	165A	200B	200B	250C
Water Storage	l	51	58	74	74	78	99	99	109
Two pass Evaporator									
Minimum Flow	l/s	8.0	9.4	11.6	11.6	12.4	14.2	14.2	16.2
Maximum Flow	l/s	29.6	34.7	43.1	43.1	46.0	52.6	52.6	60.3
Two pass Evaporator – With Turbulators									
Minimum Flow	l/s	6.6	7.8	9.7	9.7	10.3	11.8	11.8	13.5
Maximum Flow	l/s	26.6	31.2	38.7	38.7	41.3	47.2	47.2	54.1
Condenser									
Quantity of Coils	#	4/4	4/4	4/4	5/5	5/5	6/4	6/6	6/6
Coil Length	mm	1967	1967	1967	1967	1967	1967	1967	1967
Coil Height	mm	1214	1214	1214	1214	1214	1214	1214	1214
Condenser Fans									
Quantity (1)	#	4/4	4/4	4/4	5/5	5/5	6/4	6/6	6/6
Diameter	mm	800	800	800	800	800	800	800	800
Air flow per Fan	m ³ /s	5.6	5.6	5.6	5.6	5.6	5.6	5.6	5.6
Nominal RPM	rpm	860	860	860	860	860	860	860	860
Motor	kW	1.1	1.1	1.1	1.1	1.1	1.1	1.1	1.1
Minimum Starting/Operating Ambient									
Standard Unit	°C	-10	-10	-10	-10	-10	-10	-10	-10
Low-Ambient Unit (Option)	°C	-20	-20	-20	-20	-20	-20	-20	-20
Maximum ambient operation Standard ambient (9)	°C	46	46	46	46	46	46	46	46
Maximum ambient operation High ambient (9)	°C	55	55	55	55	55	55	55	55
General Unit									
Refrigerant		HFC134a	HFC134a	HFC134a	HFC134a	HFC134a	HFC134a	HFC134a	HFC134a
Number of Independent Refrigerant Circuits	#	2	2	2	2	2	2	2	2
Minimum Load (2)	%	15	15	15	15	15	15	15	15
Operating Weight	kg	3375	3410	3590	4070	4340	4500	4940	4965
Shipping Weight	kg	3320	3345	3505	3985	4250	4385	4825	4840

Notes:

1. Data containing information on two circuits shown as follows: ckt1/ckt2
2. Percent minimum load is for total machine at 10°C (50°F) ambient and 7°C (44°F) leaving chilled water temperature, not each individual circuit.
3. Net cooling capacity at Eurovent conditions, 7°C leaving water temperature and 35°C entering condenser air temperature.
4. Ratings based on sea level altitude and evaporator fouling factor 0.017645 m²K/kW
5. Unit kW input, including fans
6. Calculate with cooling capacity
7. At Evaporator water temperature: 6.6°C (44°F) / 12.2°C (54°F) - Condenser air temperature 46°C (114.8°F)
9. Maximum ambient operation is for unit at 12°C / 7°C
10. At Eurovent conditions, with 1pW Reference Sound Power, according to ISO9614

General Data

Table 4 – General Data RTAF 250-410 Standard Efficiency - Extra Low Noise

		RTAF 250	RTAF 280	RTAF 310	RTAF 350	RTAF 380	RTAF 410
		SE-XLN	SE-XLN	SE-XLN	SE-XLN	SE-XLN	SE-XLN
Eurovent Performances (1)							
Net Cooling Capacity	(kW)	860	973	1075	1195	1324	1447
Total Power input in cooling	(kW)	285	323	370	412	450	490
EER		3.02	3.01	2.9	2.9	2.94	2.95
ESEER		4.26	4.25	4.23	4.36	4.45	4.44
Eurovent Efficiency class Cooling		B	B	B	C	B	B
Sound power level	(dBA)	93	94	94	94	95	95
Middle East design condition performances (2)							
Gross cooling capacity	(kW)	714	809	891	965	1076	1180
Gross EER		2.24	2.24	2.15	2.09	2.13	2.15
Compressor							
Quantity	#	3	3	3	4	4	4
Model		85-85/70	85-100/85	100-100/100	85-85/85-85	85-100/85-100	100-100/100-100
Motor RPM	(rpm)	3000	3000	3000	3000	3000	3000
Evaporator							
Evaporator model		300D	300B	300A	500D	500C	500B
Evaporator Water Content volume	(l)	97	108	120	146	159	170
One pass evaporator							
Evap. Water Flow rate - Minimum	(l/s)	17.7	20.1	22.8	25.0	27.8	30.3
Evap. Water Flow rate - Maximum	(l/s)	65.8	74.5	84.8	92.8	103.0	112.5
One pass with turbulator evaporator							
Evap. Water Flow rate - Minimum	(l/s)	14.8	16.7	19.0	20.8	23.1	25.3
Evap. Water Flow rate - Maximum	(l/s)	59.1	66.9	76.1	83.4	92.5	101.1
Condenser							
Quantity	#	10/4	10/6	10/6	10/8	10/10	12/10
Face area per coil	(m ²)	2.4	2.4	2.4	2.4	2.4	2.4
Condenser Fan							
Quantity	#	10/4	10/6	10/6	10/8	10/10	12/10
Diameter	(mm)	800	800	800	800	800	800
Standard / High ambient fan option							
Fan / motor Type		Propeller fan / Fixed speed - AC motor					
Airflow per Fan	(m ³ /s)	5.6	5.6	5.6	5.6	5.6	5.6
Power per Motor	(kW)	1.1	1.1	1.1	1.1	1.1	1.1
Rated Amps per Motor	(A)	1.8	1.8	1.8	1.8	1.8	1.8
Rated motor RPM	(rpm)	860	860	860	860	860	860
Operating limits							
Minimum Starting / Operating Ambient (7)							
Standard ambient unit	(°C)	-10	-10	-10	-10	-10	-10
Low Ambient (Option)	(°C)	-20	-20	-20	-20	-20	-20
Maximum ambient operation Standard ambient (8)	(°C)	46	46	46	46	46	46
Maximum ambient operation High ambient (8)	(°C)	55	55	55	55	55	55
System data							
Nb of refrigerant circuit	#	2	2	2	2	2	2
Minimum cooling load % (6)	%	15	15	15	15	15	15
Shipping Weight(5)	(kg)	6570	7125	7140	8550	8935	9305
Operating Weight(5)	(kg)	6625	7185	7230	8640	9030	9405

Notes:

- (1) At Evaporator water temperature: 12°C / 7°C - Condenser air temperature 35°C according to EN14511:2013
- (2) At Evaporator water temperature: 6.6°C (44°F) / 12.2°C (54°F) - condenser air temperature 46°C (114.8°F) - FFE=1.76*10⁻⁵ m²•°C/W
- (4) Under 400V/3/50Hz
- (5) Rated Condition without Pump Package
- (6) Percent minimum load can be lowered on demand to local sales office
- (7) Minimum start-up/operation ambient based on a 2.22 m/s (5mph) wind across the condenser
- (8) Maximum ambient operation is for unit at 12°C / 7°C
- (10) At Eurovent conditios, with 1pW Reference Sound Power, according ISO9614

Electrical & system data are subject to change without notice. Please refer to unit nameplate data

General Data

Table 5 – General Data RTAF 090 – 205 High Efficiency - Standard and Low Noise

RTAF High Efficiency - Standard and Low Noise		RTAF	RTAF	RTAF	RTAF	RTAF	RTAF	RTAF	RTAF
		090	105	125	145	155	175	190	205
Eurovent Performances		HE SN&LN	HE SN&LN	HE SN&LN	HE SN&LN	HE SN&LN	HE SN&LN	HE SN&LN	HE SN&LN
Net Cooling Capacity (3) (4)	(kW)	330.5	383.2	452.4	531.9	576.7	632.1	689.1	751
Power Input (5)	(kW)	104.7	120.6	142.6	163.7	181.4	201.3	217.4	238.7
EER (3) (4) (6)	(kW/kW)	3.16	3.18	3.17	3.25	3.18	3.14	3.17	3.15
ESEER (6)	(kW/kW)	3.82	3.83	3.97	4.01	3.94	3.97	3.94	3.96
Eurovent Efficiency class Cooling		A	A	A	A	A	A	A	A
Sound power level (Standard Noise) (10)	(dBA)	95	95	96	96	97	97	98	98
Sound power level (Low Noise) (10)	(dBA)	93	93	93	93	94	94	95	95
Middle East design condition performances (7)									
Gross cooling capacity	(tons)	278	320	376	446	482	527	576	625
Gross EER	(kW/ton)	2.42	2.4	2.38	2.46	2.39	2.35	2.38	2.35
Compressor									
Quantity	#	2	2	2	2	2	2	2	2
Nominal Size (1)	tons	45/45	50/50	70/50	70/70	85/70	100/70	100/85	100/100
Evaporator									
Evaporator Model		11<5B	115A	165B	165B	165A	200B	200B	250B
Water Storage	l	51	58	74	74	78	99	99	118
Two pass Evaporator									
Minimum Flow	l/s	8.0	9.4	11.6	11.6	12.4	14.2	14.2	17.9
Maximum Flow	l/s	29.6	34.7	43.1	43.1	46.0	52.6	52.6	66.5
Two pass Evaporator – With Turbulators									
Minimum Flow	l/s	6.6	7.8	9.7	9.7	10.3	11.8	11.8	14.9
Maximum Flow	l/s	26.6	31.2	38.7	38.7	41.3	47.2	47.2	59.7
Condenser									
Quantity of Coils	#	5/5	5/5	5/5	6/6	6/6	7/5	7/7	7/7
Coil Length	mm	1967	1967	1967	1967	1967	1967	1967	1967
Coil Height	mm	1214	1214	1214	1214	1214	1214	1214	1214
Condenser Fans									
Quantity (1)	#	5/5	5/5	5/5	6/6	6/6	7/5	7/7	7/7
Diameter	mm	800	800	800	800	800	800	800	800
Air flow per Fan	m ³ /s	5.6	5.6	5.6	5.6	5.6	5.6	5.6	5.6
Nominal RPM	rpm	932	932	932	932	932	932	932	932
Motor	kW	1.4	1.4	1.4	1.4	1.4	1.4	1.4	1.4
Minimum Starting/Operating Ambient									
Standard Unit	°C	-10	-10	-10	-10	-10	-10	-10	-10
Low-Ambient Unit (Option)	°C	-20	-20	-20	-20	-20	-20	-20	-20
Maximum ambient operation Standard ambient (9)	°C	46	46	46	46	46	46	46	46
Maximum ambient operation High ambient (9)	°C	55	55	55	55	55	55	55	55
General Unit									
Refrigerant		HFC134a	HFC134a	HFC134a	HFC134a	HFC134a	HFC134a	HFC134a	HFC134a
Number of Independent Refrigerant Circuits	#	2	2	2	2	2	2	2	2
Minimum Load (2)	%	15	15	15	15	15	15	15	15
Operating Weight	kg	3595	3630	3810	4220	4485	4640	5075	5210
Shipping Weight	kg	3540	3565	3725	4135	4395	4525	4960	5075

Notes:

1. Data containing information on two circuits shown as follows: ckt1/ckt2
2. Percent minimum load is for total machine at 10°C (50°F) ambient and 7°C (44°F) leaving chilled water temperature, not each individual circuit.
3. Net cooling capacity at Eurovent conditions, 7°C leaving water temperature and 35°C entering condenser air temperature.
4. Ratings based on sea level altitude and evaporator fouling factor 0.017645 m²K/kW
5. Unit kW input, including fans
6. Calculate with cooling capacity
7. At Evaporator water temperature: 6.6°C (44°F) / 12.2°C (54°F) - Condenser air temperature 46°C (114.8°F)
9. Maximum ambient operation is for unit at 12°C / 7°C
10. At Eurovent conditions, with 1pW Reference Sound Power, according to ISO9614

General Data

Table 6 – General Data RTAF 250-410 High Efficiency - Standard and Low Noise

		RTAF 250	RTAF 280	RTAF 310	RTAF 350	RTAF 380	RTAF 410
		HE-SN & LN	HE-SN & LN	HE-SN & LN	HE-SN & LN	HE-SN & LN	HE-SN & LN
Eurovent Performances (1)							
Net Cooling Capacity	(kW)	872	986	1102	1233	1353	1456
Total Power input in cooling	(kW)	274	305	344	383	421	465
EER		3.18	3.23	3.21	3.22	3.21	3.13
ESEER		4.3	4.35	4.32	4.16	4.23	4.21
Eurovent Efficiency class Cooling		A	A	A	A	A	A
Sound power level (Standard Noise)	(dBA)	99	100	101	101	102	102
Sound power level (Low Noise)	(dBA)	96	97	98	98	98	99
Middle East design condition performances (2)							
Gross cooling capacity	(kW)	741	842	941	1070	1174	1259
Gross EER		2.37	2.42	2.4	2.41	2.41	2.35
Compressor							
Quantity	#	3	3	3	4	4	4
Model		85-85/70	85-100/85	100-100/100	85-85/85-85	85-100/85-100	100-100/100-100
Evaporator							
Evaporator model		300D	300B	300A	500D	500C	500B
Evaporator Water Content volume	(l)	97	108	120	146	159	170
One pass evaporator							
Evap. Water Flow rate - Minimum	(l/s)	17.7	20.1	22.8	25.0	27.8	30.3
Evap. Water Flow rate - Maximum	(l/s)	65.8	74.5	84.8	92.8	103.0	112.5
One pass with turbulator evaporator							
Evap. Water Flow rate - Minimum	(l/s)	14.8	16.7	19.0	20.8	23.1	25.3
Evap. Water Flow rate - Maximum	(l/s)	59.1	66.9	76.1	83.4	92.5	101.1
Condenser							
Quantity	#	12/4	12/6	14/6	12/10	12/12	12/12
Face area per coil	(m ²)	2.4	2.4	2.4	2.4	2.4	2.4
Condenser Fan							
Quantity	#	12/4	12/6	14/6	12/10	12/12	12/12
Diameter	(mm)	800	800	800	800	800	800
Standard / High ambient fan option							
Fan / motor Type		Propeller fan / Fixed speed - AC motor					
Airflow per Fan	(m ³ /s)	5.6	5.6	5.6	5.6	5.6	5.6
Power per Motor	(kW)	1.4	1.4	1.4	1.4	1.4	1.4
Rated Amps per Motor	(A)	3.4	3.4	3.4	3.4	3.4	3.4
Rated motor RPM	(rpm)	932	932	932	932	932	932
Dimensions							
Unit Length	(mm)	9390	10135	11260	12385	13510	13510
Unit Width	(mm)	2200	2200	2200	2200	2200	2200
Unit Height	(mm)	2526	2526	2526	2526	2526	2526
Operating limits							
Minimum Starting / Operating Ambient (7)							
Standard ambient unit	(°C)	-10	-10	-10	-10	-10	-10
Low Ambient (Option)	(°C)	-20	-20	-20	-20	-20	-20
Maximum ambient operation Standard ambient (8)	(°C)	46	46	46	46	46	46
Maximum ambient operation High ambient (8)	(°C)	55	55	55	55	55	55
System data							
Nb of refrigerant circuit	#	2	2	2	2	2	2
Minimum cooling load % (6)	%	15	15	15	15	15	15
Shipping Weight(5)	(kg)	6632	7058	7458	8819	8999	8939
Operating Weight(5)	(kg)	6687	7118	7548	8909	9094	9039

Notes:

- (1) At Evaporator water temperature: 12°C / 7°C - Condenser air temperature 35°C according to EN14511:2013
- (2) At Evaporator water temperature: 6.6°C (44°F) / 12.2°C (54°F) - condenser air temperature 46°C (114.8°F) - FFE=1.76*10⁻⁵ m²•°C/W
- (4) Under 400V/3/50Hz
- (5) Rated Condition without Pump Package
- (6) Percent minimum load can be lowered on demand to local sales office
- (7) Minimum start-up/operation ambient based on a 2.22 m/s (5mph) wind across the condenser
- (8) Maximum ambient operation is for unit at 12°C / 7°C

Electrical & system data are subject to change without notice. Please refer to unit nameplate data

General Data

Table 7 – General Data RTAF 090 – 205 Extra Efficiency - Standard and Low Noise

RTAF Extra Efficiency - Standard and Low Noise		RTAF	RTAF	RTAF	RTAF	RTAF	RTAF	RTAF	RTAF
		090	105	125	145	155	175	190	205
Eurovent Performances		XE SN&LN	XE SN&LN	XE SN&LN	XE SN&LN	XE SN&LN	XE SN&LN	XE SN&LN	XE SN&LN
Net Cooling Capacity (3) (4)	(kW)	326.1	380.3	447.2	526.3	569.4	632.8	689.7	751.9
Power Input (5)	(kW)	97.4	115.8	138.3	158.4	176.5	198.7	214.6	235.6
EER (3) (4) (6)	(kW/kW)	3.35	3.28	3.23	3.32	3.23	3.18	3.21	3.19
ESEER (6)	(kW/kW)	4.26	4.14	4.19	4.27	4.17	4.15	4.11	4.11
Eurovent Efficiency class Cooling		A	A	A	A	A	A	A	A
Sound power level (Standard Noise) (10)	(dBA)	94	94	95	96	97	97	98	98
Sound power level (Low Noise) (10)	(dBA)	91	91	92	93	94	94	95	95
Middle East design condition performances (7)									
Gross cooling capacity	(tons)	271	316	370	440	473	527	577	626
Gross EER	(kW/ton)	2.48	2.45	2.39	2.49	2.4	2.38	2.42	2.39
Compressor									
Quantity	#	2	2	2	2	2	2	2	2
Nominal Size (1)	tons	45/45	50/50	70/50	70/70	85/70	100/70	100/85	100/100
Evaporator									
Evaporator Model		115B	115A	165B	165B	165A	200B	200B	250B
Water Storage	l	51	58	74	74	78	99	99	118
Two pass Evaporator									
Minimum Flow	l/s	8.0	9.4	11.6	11.6	12.4	14.2	14.2	17.9
Maximum Flow	l/s	29.6	34.7	43.1	43.1	46.0	52.6	52.6	66.5
Two pass Evaporator – With Turbulators									
Minimum Flow	l/s	6.6	7.8	9.7	9.7	10.3	11.8	11.8	14.9
Maximum Flow	l/s	26.6	31.2	38.7	38.7	41.3	47.2	47.2	59.7
Condenser									
Quantity of Coils	#	5/5	5/5	5/5	6/6	6/6	7/5	7/7	7/7
Coil Length	mm	1967	1967	1967	1967	1967	1967	1967	1967
Coil Height	mm	1214	1214	1214	1214	1214	1214	1214	1214
Condenser Fans									
Quantity (1)	#	5/5	5/5	5/5	6/6	6/6	7/5	7/7	7/7
Diameter	mm	800	800	800	800	800	800	800	800
Air flow per Fan	m ³ /s	4.2	4.8	4.8	4.8	4.8	5.6	5.6	5.6
Nominal RPM	rpm	710	810	810	810	810	910	910	910
Motor	kW	0.6	0.9	0.9	0.9	0.9	1.3	1.3	1.3
Minimum Starting/Operating Ambient									
Standard Unit	°C	-10	-10	-10	-10	-10	-10	-10	-10
Low-Ambient Unit (Option)	°C	-20	-20	-20	-20	-20	-20	-20	-20
Maximum ambient operation Standard ambient (9)	°C	46	46	46	46	46	46	46	46
Maximum ambient operation High ambient (9)	°C	55	55	55	55	55	55	55	55
General Unit									
Refrigerant		HFC134a	HFC134a	HFC134a	HFC134a	HFC134a	HFC134a	HFC134a	HFC134a
Number of Independent Refrigerant Circuits	#	2	2	2	2	2	2	2	2
Minimum Load (2)	%	15	15	15	15	15	15	15	15
Operating Weight	kg	3595	3630	3810	4220	4485	4640	5075	5210
Shipping Weight	kg	3540	3565	3725	4135	4395	4525	4960	5075

Notes:

1. Data containing information on two circuits shown as follows: ckt1/ckt2
2. Percent minimum load is for total machine at 10°C (50°F) ambient and 7°C (44°F) leaving chilled water temperature, not each individual circuit.
3. Net cooling capacity at Eurovent conditions, 7°C leaving water temperature and 35°C entering condenser air temperature.
4. Ratings based on sea level altitude and evaporator fouling factor 0.017645 m²K/kW
5. Unit kW input, including fans
6. Calculate with cooling capacity
7. At Evaporator water temperature: 6.6°C (44°F) / 12.2°C (54°F) - Condenser air temperature 46°C (114.8°F)
9. Maximum ambient operation is for unit at 12°C / 7°C
10. At Eurovent conditions, with 1pW Reference Sound Power, according to ISO9614

General Data

Table 8 – General Data RTAF 250-410 Extra Efficiency - Standard and Low Noise

		RTAF 250	RTAF 280	RTAF 310	RTAF 350	RTAF 380	RTAF 410	RTAF 415
		XE-SN & LN	XE-SN & LN	XE-SN & LN	XE-SN & LN	XE-SN & LN	XE-SN & LN	XE-SN & LN
Eurovent Performances (1)								
Net Cooling Capacity	(kW)	876	993	1114	1238	1364	1471	1479
Total Power input in cooling	(kW)	283	319	359	399	440	486	469
EER		3.1	3.11	3.11	3.1	3.1	3.03	3.15
ESEER		4.29	4.33	4.32	4.43	4.51	4.46	4.45
Eurovent Efficiency class Cooling		A	A	A	A	A	B	A
Sound power level (Standard Noise)	(dBA)	99	100	101	101	102	102	103
Sound power level (Low Noise)	(dBA)	96	97	98	98	98	99	100
Middle East design condition performances (2)								
Gross cooling capacity	(kW)	731	830	933	1020	1127	1210	1228
Gross EER		2.32	2.33	2.33	2.29	2.29	2.23	2.27
Compressor								
Quantity	#	3	3	3	4	4	4	4
Model		85-85/70	85-100/85	100-100/100	85-85/85-85	85-100/ 85-100	100-100/ 100-100	100-100/ 100-100
Evaporator								
Evaporator model		300D	300B	300A	500D	500C	500B	500B
Evaporator Water Content volume	(l)	97	108	120	146	159	170	170
One pass evaporator								
Evap. Water Flow rate - Minimum	(l/s)	17.7	20.1	22.8	25.0	27.8	30.3	30.3
Evap. Water Flow rate - Maximum	(l/s)	65.8	74.5	84.8	92.8	103.0	112.5	112.5
One pass with turbulator evaporator								
Evap. Water Flow rate - Minimum	(l/s)	14.8	16.7	19.0	20.8	23.1	25.3	25.3
Evap. Water Flow rate - Maximum	(l/s)	59.1	66.9	76.1	83.4	92.5	101.1	101.1
Condenser								
Quantity	#	12/4	12/6	14/6	12/10	12/12	12/12	12/12
Face area per coil	(m ²)	2.4	2.4	2.4	2.4	2.4	2.4	2.4
Condenser Fan								
Quantity	#	12/4	12/6	14/6	12/10	12/12	12/12	12/12
Diameter	(mm)	800	800	800	800	800	800	800
Standard / High ambient fan option / Low ambient option								
Fan / motor Type		Propeller fan / Variable speed - EC motor						
Airflow per Fan	(m ³ /s)	5.6	5.6	5.6	5.6	5.6	5.6	5.6
Power per Motor	(kW)	1.3	1.3	1.3	1.3	1.3	1.3	1.3
Rated Amps per Motor	(A)	2.3	2.3	2.3	2.3	2.3	2.3	2.3
Rated motor RPM	(rpm)	910	910	910	910	910	910	910
Operating limits								
Minimum Starting / Operating Ambient (7)								
Standard ambient unit	(°C)	-10	-10	-10	-10	-10	-10	-10
Low Ambient (Option)	(°C)	-20	-20	-20	-20	-20	-20	-20
Maximum ambient operation Standard ambient (8)	(°C)	46	46	46	46	46	46	46
Maximum ambient operation High ambient (8)	(°C)	55	55	55	55	55	55	55
System data								
Nb of refrigerant circuit	#	2	2	2	2	2	2	2
Minimum cooling load % (6)	%	15	15	15	15	15	15	15
Shipping Weight(5)	(kg)	6730	7265	7605	9015	9315	9375	8939
Operating Weight(5)	(kg)	6785	7325	7695	9105	9410	9475	9039

Notes:

(1) At Evaporator water temperature: 12°C / 7°C - Condenser air temperature 35°C according to EN14511:2013

(2) At Evaporator water temperature: 6.6°C (44°F) / 12.2°C (54°F) - condenser air temperature 46°C (114.8°F) - FFE=1.76*10⁻⁵ m²•°C/W

(4) Under 400V/3/50Hz

(5) Rated Condition without Pump Package

(6) Percent minimum load can be lowered on demand to local sales office

(7) Minimum start-up/operation ambient based on a 2.22 m/s (5mph) wind across the condenser

(8) Maximum ambient operation is for unit at 12°C / 7°C

Electrical & system data are subject to change without notice. Please refer to unit nameplate data

General Data

Table 9 – General Data RTAF 090 – 205 Extra Efficiency - Extra Low Noise

RTAF Extra Efficiency - Extra Low Noise		RTAF	RTAF	RTAF	RTAF	RTAF	RTAF	RTAF	RTAF
		090	105	125	145	155	175	190	205
Eurovent Performances		XE XLN	XE XLN	XE XLN	XE XLN	XE XLN	XE XLN	XE XLN	XE XLN
Net Cooling Capacity (3) (4)	(kW)	325.5	379.9	446.7	525.7	568.6	632.5	689.4	751.6
Power Input (5)	(kW)	96.9	115.1	137.8	157.8	176.1	197.4	212.9	234.1
EER (3) (4) (6)	(kW/kW)	3.36	3.3	3.24	3.33	3.23	3.2	3.24	3.21
ESEER (6)	(kW/kW)	4.29	4.2	4.21	4.3	4.19	4.19	4.14	4.14
Eurovent Efficiency class Cooling		A	A	A	A	A	A	A	A
Sound power level (Extra Low Noise) (10)	(dBA)	88	88	88	89	90	90	91	91
Middle East design condition performances (7)									
Gross cooling capacity	(tons)	270	315	370	439	473	527	576	625
Gross EER	(kW/ton)	2.48	2.45	2.39	2.49	2.4	2.39	2.43	2.4
Compressor									
Quantity	#	2	2	2	2	2	2	2	2
Nominal Size (1)	tons	45/45	50/50	70/50	70/70	85/70	100/70	100/85	100/100
Evaporator									
Evaporator Model		115B	115A	165B	165B	165A	200B	200B	250B
Water Storage	l	51	58	74	74	78	99	99	118
Two pass Evaporator									
Minimum Flow	l/s	8.0	9.4	11.6	11.6	12.4	14.2	14.2	17.9
Maximum Flow	l/s	29.6	34.7	43.1	43.1	46.0	52.6	52.6	66.5
Two pass Evaporator – With Turbulators									
Minimum Flow	l/s	6.6	7.8	9.7	9.7	10.3	11.8	11.8	14.9
Maximum Flow	l/s	26.6	31.2	38.7	38.7	41.3	47.2	47.2	59.7
Condenser									
Quantity of Coils	#	5/5	5/5	5/5	6/6	6/6	7/5	7/7	7/7
Coil Length	mm	1967	1967	1967	1967	1967	1967	1967	1967
Coil Height	mm	1214	1214	1214	1214	1214	1214	1214	1214
Condenser Fans									
Quantity (1)	#	5/5	5/5	5/5	6/6	6/6	7/5	7/7	7/7
Diameter	mm	800	800	800	800	800	800	800	800
Air flow per Fan	m ³ /s	4.2	4.8	4.8	4.8	4.8	5.6	5.6	5.6
Nominal RPM	rpm	660	760	760	760	760	860	860	860
Motor	kW	0.5	0.8	0.8	0.8	0.8	1.1	1.1	1.1
Minimum Starting/Operating Ambient									
Standard Unit	°C	-10	-10	-10	-10	-10	-10	-10	-10
Low-Ambient Unit (Option)	°C	-20	-20	-20	-20	-20	-20	-20	-20
Maximum ambient operation Standard ambient (9)	°C	46	46	46	46	46	46	46	46
Maximum ambient operation High ambient (9)	°C	55	55	55	55	55	55	55	55
General Unit									
Refrigerant		HFC134a	HFC134a	HFC134a	HFC134a	HFC134a	HFC134a	HFC134a	HFC134a
Number of Independent Refrigerant Circuits	#	2	2	2	2	2	2	2	2
Minimum Load (2)	%	15	15	15	15	15	15	15	15
Operating Weight	kg	3695	3730	3910	4340	4605	4760	5215	5350
Shipping Weight	kg	3640	3665	3825	4255	4515	4645	5100	5215

Notes:

1. Data containing information on two circuits shown as follows: ckt1/ckt2
2. Percent minimum load is for total machine at 10°C (50°F) ambient and 7°C (44°F) leaving chilled water temperature, not each individual circuit.
3. Net cooling capacity at Eurovent conditions, 7°C leaving water temperature and 35°C entering condenser air temperature.
4. Ratings based on sea level altitude and evaporator fouling factor 0.017645 m²K/kW
5. Unit kW input, including fans
6. Calculate with cooling capacity
7. At Evaporator water temperature: 6.6°C (44°F) / 12.2°C (54°F) - Condenser air temperature 46°C (114.8°F)
9. Maximum ambient operation is for unit at 12°C / 7°C
10. At Eurovent conditions, with 1pW Reference Sound Power, according to ISO9614

General Data

Table 10 – General Data RTAF 250-410 Extra Efficiency - Extra Low Noise

		RTAF 250	RTAF 280	RTAF 310	RTAF 350	RTAF 380	RTAF 410
		XE-XLN	XE-XLN	XE-XLN	XE-XLN	XE-XLN	XE-XLN
Eurovent Performances (1)							
Net Cooling Capacity	(kW)	876	993	1114	1237	1363	1470
Total Power input in cooling	(kW)	279	316	355	397	436	481
EER		3.14	3.14	3.14	3.12	3.13	3.05
ESEER		4.36	4.39	4.4	4.46	4.56	4.51
Eurovent Efficiency class Cooling		A	A	A	A	A	B
Sound power level	(dBA)	93	94	95	95	95	95
Middle East design condition performances (2)							
Gross cooling capacity	(kW)	731	829	933	1020	1127	1209
Gross EER		2.34	2.35	2.36	2.3	2.31	2.25
Compressor							
Quantity	#	3	3	3	4	4	4
Model		85-85/70	85-100/85	100-100/100	85-85/85-85	85-100/85-100	100-100/100-100
Evaporator							
Evaporator model		300D	300B	300A	500D	500C	500B
Evaporator Water Content volume	(l)	97	108	120	146	159	170
One pass evaporator							
Evap. Water Flow rate - Minimum	(l/s)	17.7	20.1	22.8	25.0	27.8	30.3
Evap. Water Flow rate - Maximum	(l/s)	65.8	74.5	84.8	92.8	103.0	112.5
One pass with turbulator evaporator							
Evap. Water Flow rate - Minimum	(l/s)	14.8	16.7	19.0	20.8	23.1	25.3
Evap. Water Flow rate - Maximum	(l/s)	59.1	66.9	76.1	83.4	92.5	101.1
Condenser							
Quantity	#	12/4	12/6	14/6	12/10	12/12	12/12
Face area per coil	(m ²)	2.4	2.4	2.4	2.4	2.4	2.4
Condenser Fan							
Quantity	#	12/4	12/6	14/6	12/10	12/12	12/12
Diameter	(mm)	800	800	800	800	800	800
Standard / High ambient fan option / low ambient fan option							
Fan / motor Type		Propeller fan / Fixed speed - EC motor					
Airflow per Fan	(m ³ /s)	5.6	5.6	5.6	5.6	5.6	5.6
Power per Motor	(kW)	1.1	1.1	1.1	1.1	1.1	1.1
Rated Amps per Motor	(A)	1.8	1.8	1.8	1.8	1.8	1.8
Rated motor RPM	(rpm)	860	860	860	860	860	860
Operating limits							
Minimum Starting / Operating Ambient (7)							
Standard ambient unit	(°C)	-10	-10	-10	-10	-10	-10
Low Ambient (Option)	(°C)	-20	-20	-20	-20	-20	-20
Maximum ambient operation Standard ambient (8)							
Maximum ambient operation Standard ambient (8)	(°C)	46	46	46	46	46	46
Maximum ambient operation High ambient (8)							
Maximum ambient operation High ambient (8)	(°C)	55	55	55	55	55	55
System data							
Nb of refrigerant circuit	#	2	2	2	2	2	2
Minimum cooling load % (6)	%	15	15	15	15	15	15
Shipping Weight(5)	(kg)	6890	7445	7805	9235	9555	9615
Operating Weight(5)	(kg)	6945	7505	7895	9325	9650	9715

Notes:

- (1) At Evaporator water temperature: 12°C / 7°C - Condenser air temperature 35°C according to EN14511:2013
- (2) At Evaporator water temperature: 6.6°C (44°F) / 12.2°C (54°F) - condenser air temperature 46°C (114.8°F) - FFE=1.76*10⁻⁵ m²•°C/W
- (4) Under 400V/3/50Hz
- (5) Rated Condition without Pump Package
- (6) Percent minimum load can be lowered on demand to local sales office
- (7) Minimum start-up/operation ambient based on a 2.22 m/s (5mph) wind across the condenser
- (8) Maximum ambient operation is for unit at 12°C / 7°C

Electrical & system data are subject to change without notice. Please refer to unit nameplate data

General Data

Table 11 – General Data RTAF 090 – 245 High Seasonal Efficiency - Standard and Low Noise

RTAF High Seasonal Efficiency - Standard and Low Noise		RTAF	RTAF	RTAF	RTAF	RTAF	RTAF	RTAF	RTAF	RTAF	
		090	105	125	145	155	175	190	205	245	
Eurovent Performances		HSE SN&LN		HSE SN&LN		HSE SN&LN		HSE SN&LN		HSE SN&LN	
Net Cooling Capacity (3) (4)	(kW)	330	383	452	534	576	638	695	755	875	
Power Input (5)	(kW)	101.2	120.8	145.3	167.4	185.8	207.8	224.2	245.9	307	
EER (3) (4) (6)	(kW/kW)	3.26	3.17	3.11	3.19	3.1	3.07	3.1	3.07	2.85	
ESEER (6)	(kW/kW)	4.42	4.37	4.55	4.71	4.61	4.53	4.53	4.53	4.29	
Eurovent Efficiency class Cooling		A	A	A	A	A	B	A	B	C	
Sound power level (Standard Noise) (10)	(dBA)	94	94	95	96	97	97	98	98	104	
Sound power level (Low Noise) (10)	(dBA)	91	91	92	93	94	94	95	95	101	
Middle East design condition performances (7)		HSE SN&LN		HSE SN&LN		HSE SN&LN		HSE SN&LN		HSE SN&LN	
Gross cooling capacity	(tons)	274	320	376	448	482	535	586	632	718	
Gross EER	(kW/ton)	2.4	2.35	2.29	2.39	2.31	2.29	2.34	2.3	2.11	
Compressor		HSE SN&LN		HSE SN&LN		HSE SN&LN		HSE SN&LN		HSE SN&LN	
Quantity	#	2	2	2	2	2	2	2	2	2	
Nominal Size (1)	tons	45/45	50/50	70/50	70/70	85/70	100/70	100/85	100/100	120/120	
Evaporator		HSE SN&LN		HSE SN&LN		HSE SN&LN		HSE SN&LN		HSE SN&LN	
Evaporator Model		115B	115A	165B	165B	165A	200B	200B	250B	250B	
Water Storage	l	51	58	74	74	78	99	99	118	118	
Two pass Evaporator		HSE SN&LN		HSE SN&LN		HSE SN&LN		HSE SN&LN		HSE SN&LN	
Minimum Flow	l/s	8.0	9.4	11.6	11.6	12.4	14.2	14.2	17.9	17.9	
Maximum Flow	l/s	29.6	34.7	43.1	43.1	46.0	52.6	52.6	66.5	66.5	
Two pass Evaporator – With Turbulators		HSE SN&LN		HSE SN&LN		HSE SN&LN		HSE SN&LN		HSE SN&LN	
Minimum Flow	l/s	6.6	7.8	9.7	9.7	10.3	11.8	11.8	14.9	14.9	
Maximum Flow	l/s	26.6	31.2	38.7	38.7	41.3	47.2	47.2	59.7	59.7	
Condenser		HSE SN&LN		HSE SN&LN		HSE SN&LN		HSE SN&LN		HSE SN&LN	
Quantity of Coils	#	5/5	5/5	5/5	6/6	6/6	7/5	7/7	7/7	7/7	
Coil Length	mm	1967	1967	1967	1967	1967	1967	1967	1967	1967	
Coil Height	mm	1214	1214	1214	1214	1214	1214	1214	1214	1214	
Condenser Fans		HSE SN&LN		HSE SN&LN		HSE SN&LN		HSE SN&LN		HSE SN&LN	
Quantity (1)	#	5/5	5/5	5/5	6/6	6/6	7/5	7/7	7/7	7/7	
Diameter	mm	800	800	800	800	800	800	800	800	800	
Air flow per Fan	m ³ /s	4.2	4.8	4.8	4.8	4.8	5.6	5.6	5.6	5.6	
Nominal RPM	rpm	710	810	810	810	810	910	910	910	910	
Motor	kW	0.6	0.9	0.9	0.9	0.9	1.3	1.3	1.3	1.3	
Minimum Starting/Operating Ambient		HSE SN&LN		HSE SN&LN		HSE SN&LN		HSE SN&LN		HSE SN&LN	
Standard Unit	°C	-10	-10	-10	-10	-10	-10	-10	-10	-10	
Low-Ambient Unit (Option)	°C	-20	-20	-20	-20	-20	-20	-20	-20	-20	
Maximum ambient operation Standard ambient (9)	°C	46	46	46	46	46	46	46	46	46	
Maximum ambient operation High ambient (9)	°C	55	55	55	55	55	55	55	55	46	
General Unit		HSE SN&LN		HSE SN&LN		HSE SN&LN		HSE SN&LN		HSE SN&LN	
Refrigerant		HFC134a	HFC134a	HFC134a	HFC134a	HFC134a	HFC134a	HFC134a	HFC134a	HFC134a	
Number of Independent Refrigerant Circuits	#	2	2	2	2	2	2	2	2	2	
Minimum Load (2)	%	15	15	15	15	15	15	15	15	30	
Operating Weight	kg	3700	3735	3915	4320	4585	4850	5325	5460	5460	
Shipping Weight	kg	3645	3670	3830	4235	4495	4735	5210	5325	5393	

Notes:

1. Data containing information on two circuits shown as follows: ckt1/ckt2
2. Percent minimum load is for total machine at 10°C (50°F) ambient and 7°C (44°F) leaving chilled water temperature, not each individual circuit.
3. Net cooling capacity at Eurovent conditions, 7°C leaving water temperature and 35°C entering condenser air temperature.
4. Ratings based on sea level altitude and evaporator fouling factor 0.017645 m²K/kW
5. Unit kW input, including fans
6. Calculate with cooling capacity
7. At Evaporator water temperature: 6.6°C (44°F) / 12.2°C (54°F) - Condenser air temperature 46°C (114.8°F)
9. Maximum ambient operation is for unit at 12°C / 7°C
10. At Eurovent conditions, with 1pW Reference Sound Power, according to ISO9614

General Data

Table 12 – General Data RTAF 250-450 High Seasonal Efficiency - Standard and Low Noise

		RTAF	RTAF	RTAF	RTAF	RTAF	RTAF	RTAF
		250	280	310	350	380	410	450
		HSE-SN&LN	HSE-SN&LN	HSE-SN&LN	HSE-SN&LN	HSE-SN&LN	HSE-SN&LN	HSE-SN&LN
Eurovent Performances (1)								
Net Cooling Capacity	(kW)	882	999	1118	1243	1369	1473	1586
Total Power input in cooling	(kW)	291	328	368	410	450	496	558
EER		3.03	3.04	3.04	3.03	3.04	2.97	2.84
ESEER		4.4	4.43	4.46	4.59	4.62	4.56	4.41
Eurovent Efficiency class Cooling		B	B	B	B	B	B	C
Sound power level (Standard Noise)	(dBA)	99	100	101	101	102	102	107
Sound power level (Low Noise)	(dBA)	96	97	98	98	98	99	104
Middle East design condition performances (2)								
Gross cooling capacity	(kW)	727	826	925	1024	1131	1210	1298
Gross EER		2.23	2.25	2.25	2.23	2.25	2.18	2.09
Compressor								
Quantity	#	3	3	3	4	4	4	4
Model		85-85/70	85-100/85	100-100/100	85-85/85-85	85-100/85-100	100-100/100-100	120-100/120-100
Evaporator								
Evaporator model		300D	300B	300A	500D	500C	500B	500B
Evaporator Water Content volume	(l)	97	108	120	146	159	170	170
One pass evaporator								
Evap. Water Flow rate - Minimum	(l/s)	17.7	20.1	22.8	25.0	27.8	30.3	30.3
Evap. Water Flow rate - Maximum	(l/s)	65.8	74.5	84.8	92.8	103.0	112.5	112.5
One pass with turbulator evaporator								
Evap. Water Flow rate - Minimum	(l/s)	14.8	16.7	19.0	20.8	23.1	25.3	25.3
Evap. Water Flow rate - Maximum	(l/s)	59.1	66.9	76.1	83.4	92.5	101.1	101.1
Condenser								
Quantity	#	12/4	12/6	14/6	12/10	12/12	12/12	12/12
Face area per coil	(m ²)	2.4	2.4	2.4	2.4	2.4	2.4	2.4
Condenser Fan								
Quantity	#	12/4	12/6	14/6	12/10	12/12	12/12	12/12
Diameter	(mm)	800	800	800	800	800	800	800
Standard / High ambient fan option / Low ambient fan option								
Fan / motor Type		Propeller fan / Variable speed - EC motor						
Airflow per Fan	(m ³ /s)	5.6	5.6	5.6	5.6	5.6	5.6	5.6
Power per Motor	(kW)	1.3	1.3	1.3	1.3	1.3	1.3	1.3
Rated Amps per Motor	(A)	2.3	2.3	2.3	2.3	2.3	2.3	2.3
Rated motor RPM	(rpm)	910	910	910	910	910	910	910
Operating limits								
Minimum Starting / Operating Ambient (7)								
Standard ambient unit	(°C)	-10	-10	-10	-10	-10	-10	-10
Low Ambient (Option)	(°C)	-20	-20	-20	-20	-20	-20	-20
Maximum ambient operation Standard ambient (8)	(°C)	46	46	46	46	46	46	46
Maximum ambient operation High ambient (8)	(°C)	55	55	55	55	55	55	46
System data								
Nb of refrigerant circuit	#	2	2	2	2	2	2	2
Minimum cooling load % (6)	%	10	10	10	10	10	10	10
Shipping Weight(5)	(kg)	6950	7515	7855	9255	9555	9615	9800
Operating Weight(5)	(kg)	7005	7575	7945	9345	9650	9715	9715

Notes:

- (1) At Evaporator water temperature: 12°C / 7°C - Condenser air temperature 35°C according to EN14511:2013
 - (2) At Evaporator water temperature: 6.6°C (44°F) / 12.2°C (54°F) - condenser air temperature 46°C (114.8°F) - FFE=1.76*10⁻⁵ m²•°C/W
 - (4) Under 400V/3/50Hz
 - (5) Rated Condition without Pump Package
 - (6) Percent minimum load can be lowered on demand to local sales office
 - (7) Minimum start-up/operation ambient based on a 2.22 m/s (5mph) wind across the condenser
 - (8) Maximum ambient operation is for unit at 12°C / 7°C
- Electrical & system data are subject to change without notice. Please refer to unit nameplate data

General Data

Table 13 – General Data RTAF 090 – 245 High Seasonal Efficiency - Extra Low Noise

RTAF High Seasonal Efficiency - Extra Low Noise		RTAF	RTAF	RTAF	RTAF	RTAF	RTAF	RTAF	RTAF	RTAF
		090	105	125	145	155	175	190	205	245
Eurovent Performances		HSE XLN	HSE XLN	HSE XLN	HSE XLN	HSE XLN	HSE XLN	HSE XLN	HSE XLN	HSE-XLN
Net Cooling Capacity (3) (4)	(kW)	330	383	451	533	575	638	694	755	875
Power Input (5)	(kW)	100.3	119.3	144.1	165.5	184.3	205.8	221	242.8	304
EER (3) (4) (6)	(kW/kW)	3.29	3.21	3.13	3.22	3.12	3.1	3.14	3.11	2.88
ESEER (6)	(kW/kW)	4.46	4.43	4.62	4.77	4.68	4.62	4.62	4.61	4.36
Eurovent Efficiency class Cooling		A	A	A	A	A	A	A	A	C
Sound power level (Extra Low Noise) (10)	(dBA)	88	88	88	89	90	90	91	91	97
Middle East design condition performances (7)										
Gross cooling capacity	(tons)	273	319	375	445	476	530	585	632	717
Gross EER	(kW/ton)	2.41	2.37	2.3	2.39	2.29	2.29	2.36	2.32	2.13
Compressor										
Quantity	#	2	2	2	2	2	2	2	2	2
Nominal Size (1)	tons	45/45	50/50	70/50	70/70	85/70	100/70	100/85	100/100	120/120
Evaporator										
Evaporator Model		115B	115A	165B	165B	165A	200B	200B	250B	250B
Water Storage	l	51	58	74	74	78	99	99	118	118
Two pass Evaporator										
Minimum Flow	l/s	8.0	9.4	11.6	11.6	12.4	14.2	14.2	17.9	17.9
Maximum Flow	l/s	29.6	34.7	43.1	43.1	46.0	52.6	52.6	66.5	66.5
Two pass Evaporator – With Turbulators										
Minimum Flow	l/s	6.6	7.8	9.7	9.7	10.3	11.8	11.8	14.9	14.9
Maximum Flow	l/s	26.6	31.2	38.7	38.7	41.3	47.2	47.2	59.7	59.7
Condenser										
Quantity of Coils	#	5/5	5/5	5/5	6/6	6/6	7/5	7/7	7/7	7/7
Coil Length	mm	1967	1967	1967	1967	1967	1967	1967	1967	1967
Coil Height	mm	1214	1214	1214	1214	1214	1214	1214	1214	1214
Condenser Fans										
Quantity (1)	#	5/5	5/5	5/5	6/6	6/6	7/5	7/7	7/7	7/7
Diameter	mm	800	800	800	800	800	800	800	800	800
Air flow per Fan	m ³ /s	4.2	4.8	4.8	4.8	4.8	5.6	5.6	5.6	5.6
Nominal RPM	rpm	660	760	760	760	760	860	860	860	860
Motor	kW	0.5	0.8	0.8	0.8	0.8	1.1	1.1	1.1	1.1
Minimum Starting/Operating Ambient										
Standard Unit	°C	-10	-10	-10	-10	-10	-10	-10	-10	-10
Low-Ambient Unit (Option)	°C	-20	-20	-20	-20	-20	-20	-20	-20	-20
Maximum ambient operation Standard ambient (9)	°C	46	46	46	46	46	46	46	46	46
Maximum ambient operation High ambient (9)	°C	55	55	55	55	55	55	55	55	46
General Unit										
Refrigerant		HFC134a	HFC134a	HFC134a	HFC134a	HFC134a	HFC134a	HFC134a	HFC134a	HFC134a
Number of Independent Refrigerant Circuits	#	2	2	2	2	2	2	2	2	2
Minimum Load (2)	%	15	15	15	15	15	15	15	15	30
Operating Weight	kg	3800	3835	4015	4440	4705	4970	5465	5600	5600
Shipping Weight	kg	3745	3770	3930	4355	4615	4855	5350	5465	5393

Notes:

1. Data containing information on two circuits shown as follows: ckt1/ckt2
2. Percent minimum load is for total machine at 10°C (50°F) ambient and 7°C (44°F) leaving chilled water temperature, not each individual circuit.
3. Net cooling capacity at Eurovent conditions, 7°C leaving water temperature and 35°C entering condenser air temperature.
4. Ratings based on sea level altitude and evaporator fouling factor 0.017645 m²K/kW
5. Unit kW input, including fans
6. Calculate with cooling capacity
7. At Evaporator water temperature: 6.6°C (44°F) / 12.2°C (54°F) - Condenser air temperature 46°C (114.8°F)
9. Maximum ambient operation is for unit at 12°C / 7°C
10. At Eurovent conditions, with 1pW Reference Sound Power, according to ISO9614

General Data

Table 14 – General Data RTAF 250-450 High Seasonal Efficiency - Extra Low Noise

		RTAF 250	RTAF 280	RTAF 310	RTAF 350	RTAF 380	RTAF 410	RTAF 450
		HSE-XLN	HSE-XLN	HSE-XLN	HSE-XLN	HSE-XLN	HSE-XLN	HSE-XLN
Eurovent Performances (1)								
Net Cooling Capacity	(kW)	882	999	1117	1243	1369	1472	1585
Total Power input in cooling	(kW)	288	324	364	406	445	491	554
EER		3.06	3.08	3.07	3.06	3.08	3	2.86
ESEER		4.51	4.51	4.53	4.66	4.69	4.63	4.51
Eurovent Efficiency class Cooling		B	B	B	B	B	B	C
Sound power level	(dBA)	93	94	95	95	95	95	103
Middle East design condition performances (2)								
Gross cooling capacity	(kW)	727	826	925	1023	1130	1210	1298
Gross EER		2.25	2.27	2.27	2.25	2.27	2.2	2.1
Compressor								
Quantity	#	3	3	3	4	4	4	4
Model		85-85/70	85-100/85	100-100/100	85-85/85-85	85-100/85-100	100-100/100-100	120-100/120-100
Evaporator								
Evaporator model		300D	300B	300A	500D	500C	500B	500B
Evaporator Water Content volume	(l)	97	108	120	146	159	170	170
One pass evaporator								
Evap. Water Flow rate - Minimum	(l/s)	17.7	20.1	22.8	25.0	27.8	30.3	30.3
Evap. Water Flow rate - Maximum	(l/s)	65.8	74.5	84.8	92.8	103.0	112.5	112.5
One pass with turbulator evaporator								
Evap. Water Flow rate - Minimum	(l/s)	14.8	16.7	19.0	20.8	23.1	25.3	25.3
Evap. Water Flow rate - Maximum	(l/s)	59.1	66.9	76.1	83.4	92.5	101.1	101.1
Condenser								
Quantity	#	12/4	12/6	14/6	12/10	12/12	12/12	12/12
Face area per coil	(m ²)	2.4	2.4	2.4	2.4	2.4	2.4	2.4
Condenser Fan								
Quantity	#	12/4	12/6	14/6	12/10	12/12	12/12	12/12
Diameter	(mm)	800	800	800	800	800	800	800
Standard / High ambient fan option / Low ambient fan option								
Fan / motor Type		Propeller fan / Variable speed - EC motor						
Airflow per Fan	(m ³ /s)	5.6	5.6	5.6	5.6	5.6	5.6	5.6
Power per Motor	(kW)	1.1	1.1	1.1	1.1	1.1	1.1	1.1
Rated Amps per Motor	(A)	1.8	1.8	1.8	1.8	1.8	1.8	1.8
Rated motor RPM	(rpm)	860	860	860	860	860	860	860
Operating limits								
Minimum Starting / Operating Ambient (7)								
Standard ambient unit	(°C)	-10	-10	-10	-10	-10	-10	-10
Low Ambient (Option)	(°C)	-20	-20	-20	-20	-20	-20	-20
Maximum ambient operation								
Standard ambient (8)	(°C)	46	46	46	46	46	46	46
Maximum ambient operation High ambient (8)	(°C)	55	55	55	55	55	55	46
System data								
Nb of refrigerant circuit	#	2	2	2	2	2	2	2
Minimum cooling load % (6)	%	10	10	10	10	10	10	10
Shipping Weight(5)	(kg)	7110	7695	8055	9475	9795	9855	9800
Operating Weight(5)	(kg)	7165	7755	8145	9565	9890	9955	9955

Notes:

(1) At Evaporator water temperature: 12°C / 7°C - Condenser air temperature 35°C according to EN14511:2013

(2) At Evaporator water temperature: 6.6°C (44°F) / 12.2°C (54°F) - condenser air temperature 46°C (114.8°F) - FFE=1.76*10⁻⁵ m²•°C/W

(4) Under 400V/3/50Hz

(5) Rated Condition without Pump Package

(6) Percent minimum load can be lowered on demand to local sales office

(7) Minimum start-up/operation ambient based on a 2.22 m/s (5mph) wind across the condenser

(8) Maximum ambient operation is for unit at 12°C / 7°C

Electrical & system data are subject to change without notice. Please refer to unit nameplate data

General Data

Table 15 – General Data RTAF 090-205 High Seasonal Efficiency Short - Standard and Low Noise

		RTAF 090	RTAF 105	RTAF 125	RTAF 145	RTAF 155	RTAF 175	RTAF 190	RTAF 205
Eurovent Performances (1)		HSS-SN&LN HSS-SN&LN HSS-SN&LN HSS-SN&LN HSS-SN&LN HSS-SN&LN HSS-SN&LN HSS-SN&LN							
Net Cooling Capacity	(kW)	330	378	445	529	571	621	681	736
Total Power input in cooling	(kW)	106	125	151	172	192	214	229	252
EER		3.11	3.03	2.94	3.08	2.98	2.9	2.98	2.92
ESEER		4.24	4.17	4.33	4.44	4.38	4.38	4.4	4.39
Eurovent Efficiency class Cooling		A	B	B	B	B	C	B	B
Sound power level (Standard Noise)	(dBA)	95	95	95	96	96	97	97	97
Sound power level (Low Noise)	(dBA)	92	92	92	93	93	94	94	94
Cooling application data (1)									
Gross cooling capacity	(kW)	272	310	360	436	466	503	558	599
Gross EER		2.31	2.22	2.13	2.27	2.17	2.1	2.19	2.13
Middle East design condition performances (2)									
Gross cooling capacity	(kW)	272	310	360	436	466	503	558	599
Gross power input	(kW)	118	140	169	192	214	239	255	281
Gross EER		2.31	2.22	2.13	2.27	2.17	2.10	2.19	2.13
Compressor									
Quantity	#	2	2	2	2	2	2	2	2
Model		45/45	50/50	70/50	70/70	85/70	100/70	100/85	100/100
Evaporator									
Evaporator model		115B	115A	165B	165B	165A	200B	200B	250C
Evaporator Water Content volume	(l)	51	58	74	74	78	99	99	109
Two pass evaporator									
Evap. Water Flow rate - Minimum	(l/s)	8.0	9.4	11.6	11.6	12.4	14.2	14.2	16.2
Evap. Water Flow rate - Maximum	(l/s)	29.6	34.7	43.1	43.1	46.0	52.6	52.6	60.3
Two pass with turbulator evaporator									
Evap. Water Flow rate - Minimum	(l/s)	6.6	7.8	9.7	9.7	10.3	11.8	11.8	13.5
Evap. Water Flow rate - Maximum	(l/s)	26.6	31.2	38.7	38.7	41.3	47.2	47.2	54.1
Condenser									
Quantity	#	4/4	4/4	4/4	5/5	5/5	6/4	6/6	6/6
Face area per coil	(m ²)	2.4	2.4	2.4	2.4	2.4	2.4	2.4	2.4
Condenser Fan									
Quantity	#	4/4	4/4	4/4	5/5	5/5	6/4	6/6	6/6
Diameter	(mm)	800	800	800	800	800	800	800	800
Standard / High ambient fan option / Low ambient fan option									
Fan / motor Type		Propeller fan / Variable speed - EC motor							
Airflow per Fan	(m ³ /h)	20000	20000	20000	20000	20000	20000	20000	20000
Rated motor RPM	(rpm)	910	910	910	910	910	910	910	910
Operating limits									
Minimum Starting / Operating Ambient (7)									
Standard ambient unit	(°C)	-10	-10	-10	-10	-10	-10	-10	-10
Low Ambient (Option)	(°C)	-20	-20	-20	-20	-20	-20	-20	-20
Maximum ambient operation Standard ambient (8)	(°C)	46	46	46	46	46	46	46	46
Maximum ambient operation High ambient (8)	(°C)	55	55	55	55	55	55	55	55
System data									
Nb of refrigerant circuit	#	2	2	2	2	2	2	2	2
Minimum cooling load % (6)	%	30	30	30	30	30	30	30	30
Shipping Weight(5)	(kg)	3345	3370	3530	3990	4250	4495	4955	4975
Operating Weight(5)	(kg)	3400	3435	3615	4075	4340	4610	5070	5100

Notes:

- (1) At Evaporator water temperature: 12°C / 7°C - Condenser air temperature 35°C according to EN14511:2013
- (2) At Evaporator water temperature: 6.6°C (44°F) / 12.2°C (54°F) - condenser air temperature 46°C (114.8°F) - FFE=1.76*10⁻⁵ m²•°C/W
- (4) Under 400V/3/50Hz
- (5) Rated Condition without Pump Package
- (6) Percent minimum load can be lowered on demand to local sales office
- (7) Minimum start-up/operation ambient based on a 2.22 m/s (5mph) wind across the condenser
- (8) Maximum ambient operation is for unit at 12°C / 7°C

Electrical & system data are subject to change without notice. Please refer to unit nameplate data

General Data

Table 16 – General Data RTAF 250-410 High Seasonal Efficiency Short - Standard and Low Noise

		RTAF	RTAF	RTAF	RTAF	RTAF	RTAF
		250	280	310	350	380	410
Eurovent Performances (1)		HSS-SN&LN	HSS-SN&LN	HSS-SN&LN	HSS-SN&LN	HSS-SN&LN	HSS-SN&LN
Net Cooling Capacity	(kW)	866	979	1077	1200	1330	1450
Total Power input in cooling	(kW)	297	336	383	426	464	504
EER		2.92	2.92	2.81	2.82	2.87	2.88
ESEER		4.37	4.27	4.23	4.4	4.45	4.49
Eurovent Efficiency class Cooling		B	B	C	C	C	C
Sound power level (Standard Noise)	(dBA)	99	100	101	101	101	102
Sound power level (Low Noise)	(dBA)	96	97	98	98	98	99
Middle East design condition performances (2)							
Gross cooling capacity	(kW)	705	800	874	969	1079	1180
Gross EER		2.12	2.13	2.04	2.03	2.08	2.09
Compressor							
Quantity	#	3	3	3	4	4	4
Model		85-85/70	85-100/85	100-100/100	85-85/85-85	85-100/85-100	100-100/100-100
Evaporator							
Quantity	#	1	1	1	1	1	1
Evaporator model		300D	300B	300A	500D	500C	500B
Evaporator Water Content volume	(l)	97	108	120	146	159	170
One pass evaporator							
Evap. Water Flow rate - Minimum	(l/s)	17.7	20.1	22.8	25.0	27.8	30.3
Evap. Water Flow rate - Maximum	(l/s)	65.8	74.5	84.8	92.8	103.0	112.5
One pass with turbulator evaporator							
Evap. Water Flow rate - Minimum	(l/s)	14.8	16.7	19.0	20.8	23.1	25.3
Evap. Water Flow rate - Maximum	(l/s)	59.1	66.9	76.1	83.4	92.5	101.1
Condenser							
Quantity	#	10/4	10/6	10/6	10/8	10/10	12/10
Face area per coil	(m ²)	2.4	2.4	2.4	2.4	2.4	2.4
Condenser Fan							
Quantity	#	10/4	10/6	10/6	10/8	10/10	12/10
Diameter	(mm)	800	800	800	800	800	800
Standard / High ambient fan option / Low ambient fan option							
Fan / motor Type		Propeller fan / Variable speed - EC motor					
Airflow per Fan	(m ³ /s)	5.6	5.6	5.6	5.6	5.6	5.6
Power per Motor	(kW)	1.3	1.3	1.3	1.3	1.3	1.3
Rated Amps per Motor	(A)	2.3	2.3	2.3	2.3	2.3	2.3
Rated motor RPM	(rpm)	910	910	910	910	910	910
Operating limits							
Minimum Starting / Operating Ambient (7)							
Standard ambient unit	(°C)	-10	-10	-10	-10	-10	-10
Low Ambient (Option)	(°C)	-20	-20	-20	-20	-20	-20
Maximum ambient operation Standard ambient (8)	(°C)	46	46	46	46	46	46
Maximum ambient operation High ambient (8)	(°C)	55	55	55	55	55	55
System data							
Nb of refrigerant circuit	#	2	2	2	2	2	2
Minimum cooling load % (6)	%	10	10	10	10	10	10
Shipping Weight(5)	(kg)	6630	7215	7235	8610	8975	9325
Operating Weight(5)	(kg)	6685	7275	7325	8700	9070	9425

Notes:

- (1) At Evaporator water temperature: 12°C / 7°C - Condenser air temperature 35°C according to EN14511:2013
- (2) At Evaporator water temperature: 6.6°C (44°F) / 12.2°C (54°F) - condenser air temperature 46°C (114.8°F) - FFE=1.76*10⁻⁵ m²•°C/W
- (4) Under 400V/3/50Hz
- (5) Rated Condition without Pump Package
- (6) Percent minimum load can be lowered on demand to local sales office
- (7) Minimum start-up/operation ambient based on a 2.22 m/s (5mph) wind across the condenser
- (8) Maximum ambient operation is for unit at 12°C / 7°C

Electrical & system data are subject to change without notice. Please refer to unit nameplate data

General Data

Table 17 – General Data RTAF 090-205 High Seasonal Efficiency Short - Extra Low Noise

		RTAF 090	RTAF 105	RTAF 125	RTAF 145	RTAF 155	RTAF 175	RTAF 190	RTAF 205
Eurovent Performances (1)		HSS-XLN	HSS-XLN	HSS-XLN	HSS-XLN	HSS-XLN	HSS-XLN	HSS-XLN	HSS-XLN
	(kW)	330	378	445	529	570	621	681	735
Total Power input in cooling	(kW)	105	123	150	170	190	212	226	249
EER		3.16	3.07	2.97	3.11	3.01	2.92	3.01	2.95
ESEER		4.33	4.26	4.41	4.54	4.46	4.46	4.48	4.46
Eurovent Efficiency class Cooling		A	B	B	A	B	B	B	B
Sound power level (Extra Low Noise)	(dBA)	88	89	89	89	90	90	91	91
Cooling application data (1)									
Gross cooling capacity	(kW)	272	310	360	436	466	503	558	599
Gross EER		2.34	2.24	2.14	2.29	2.19	2.12	2.21	2.15
Middle East design condition performances (2)									
Gross cooling capacity	(kW)	272	310	360	436	466	503	558	599
Gross power input	(kW)	117	138	168	190	212	238	253	279
Gross EER		2.34	2.24	2.14	2.29	2.19	2.12	2.21	2.15
Compressor									
Quantity	#	2	2	2	2	2	2	2	2
Model		45/45	50/50	70/50	70/70	85/70	100/70	100/85	100/100
Evaporator									
Evaporator Water Content volume	(l)	51	58	74	74	78	99	99	109
Two pass evaporator									
Evap. Water Flow rate - Minimum	(l/s)	8.0	9.4	11.6	11.6	12.4	14.2	14.2	16.2
Evap. Water Flow rate - Maximum	(l/s)	29.6	34.7	43.1	43.1	46.0	52.6	52.6	60.3
Two pass with turbulator evaporator									
Evap. Water Flow rate - Minimum	(l/s)	6.6	7.8	9.7	9.7	10.3	11.8	11.8	13.5
Evap. Water Flow rate - Maximum	(l/s)	26.6	31.2	38.7	38.7	41.3	47.2	47.2	54.1
Condenser									
Quantity	#	4/4	4/4	4/4	5/5	5/5	6/4	6/6	6/6
Face area per coil	(m ²)	2.4	2.4	2.4	2.4	2.4	2.4	2.4	2.4
Condenser Fan									
Quantity	#	4/4	4/4	4/4	5/5	5/5	6/4	6/6	6/6
Diameter	(mm)	800	800	800	800	800	800	800	800
Standard / High ambient fan option / Low ambient fan option									
Fan / motor Type		Propeller fan / Variable speed - EC motor							
Airflow per Fan	(m ³ /h)	20000	20000	20000	20000	20000	20000	20000	20000
Rated motor RPM	(rpm)	860	860	860	860	860	860	860	860
Operating limits									
Minimum Starting / Operating Ambient (7)									
Standard ambient unit	(°C)	-10	-10	-10	-10	-10	-10	-10	-10
Low Ambient (Option)	(°C)	-20	-20	-20	-20	-20	-20	-20	-20
Maximum ambient operation Standard ambient (8)	(°C)	46	46	46	46	46	46	46	46
Maximum ambient operation High ambient (8)	(°C)	55	55	55	55	55	55	55	55
System data									
Nb of refrigerant circuit	#	2	2	2	2	2	2	2	2
Minimum cooling load % (6)	%	30	30	30	30	30	30	30	30
Shipping Weight(5)	(kg)	3425	3450	3610	4090	4150	4595	5075	5095
Operating Weight(5)	(kg)	3480	3515	3695	4175	4240	4710	5190	5220

Notes:

- (1) At Evaporator water temperature: 12°C / 7°C - Condenser air temperature 35°C according to EN14511:2013
- (2) At Evaporator water temperature: 6.6°C (44°F) / 12.2°C (54°F) - condenser air temperature 46°C (114.8°F) - FFE=1.76*10⁻⁵ m²•°C/W
- (4) Under 400V/3/50Hz
- (5) Rated Condition without Pump Package
- (6) Percent minimum load can be lowered on demand to local sales office
- (7) Minimum start-up/operation ambient based on a 2.22 m/s (5mph) wind across the condenser
- (8) Maximum ambient operation is for unit at 12°C / 7°C

Electrical & system data are subject to change without notice. Please refer to unit nameplate data

General Data

Table 18 – General Data RTAF 250-410 High Seasonal Efficiency Short - Extra Low Noise

		RTAF 250	RTAF 280	RTAF 310	RTAF 350	RTAF 380	RTAF 410
		HSS-XLN	HSS-XLN	HSS-XLN	HSS-XLN	HSS-XLN	HSS-XLN
Eurovent Performances (1)							
Net Cooling Capacity	(kW)	866	979	1077	1200	1330	1450
Total Power input in cooling	(kW)	297	336	383	426	464	504
EER		2.94	2.94	2.83	2.84	2.89	2.9
ESEER		4.44	4.34	4.3	4.48	4.53	4.55
Eurovent Efficiency class Cooling		B	B	C	C	C	C
Sound power level	(dBA)	93	94	94	94	95	95
Middle East design condition performances (2)							
Gross cooling capacity	(kW)	705	800	874	968	1079	1180
Gross EER		2.14	2.15	2.05	2.05	2.09	2.11
Compressor							
Quantity	#	3	3	3	4	4	4
Model		85-85/70	85-100/85	100-100/100	85-85/85-85	85-100/85-100	100-100/100-100
Evaporator							
Evaporator model		300D	300B	300A	500D	500C	500B
Evaporator Water Content volume	(l)	97	108	120	146	159	170
One pass evaporator							
Evap. Water Flow rate - Minimum	(l/s)	17.7	20.1	22.8	25.0	27.8	30.3
Evap. Water Flow rate - Maximum	(l/s)	65.8	74.5	84.8	92.8	103.0	112.5
One pass with turbulator evaporator							
Evap. Water Flow rate - Minimum	(l/s)	14.8	16.7	19.0	20.8	23.1	25.3
Evap. Water Flow rate - Maximum	(l/s)	59.1	66.9	76.1	83.4	92.5	101.1
Condenser							
Quantity	#	10/4	10/6	10/6	10/8	10/10	12/10
Face area per coil	(m ²)	2.4	2.4	2.4	2.4	2.4	2.4
Condenser Fan							
Quantity	#	10/4	10/6	10/6	10/8	10/10	12/10
Diameter	(mm)	800	800	800	800	800	800
Standard / High ambient fan option / Low ambient fan option							
Fan / motor Type		Propeller fan / Variable speed - EC motor					
Airflow per Fan	(m ³ /s)	5.6	20000	20000	20000	20000	20000
Power per Motor	(kW)	1.1	1.1	1.1	1.1	1.1	1.1
Rated Amps per Motor	(A)	1.8	1.8	1.8	1.8	1.8	1.8
Rated motor RPM	(rpm)	860	860	860	860	860	860
Operating limits							
Minimum Starting / Operating Ambient (7)							
Standard ambient unit	(°C)	-10	-10	-10	-10	-10	-10
Low Ambient (Option)	(°C)	-20	-20	-20	-20	-20	-20
Maximum ambient operation Standard ambient (8)	(°C)	46	46	46	46	46	46
Maximum ambient operation High ambient (8)	(°C)	55	55	55	55	55	55
System data							
Nb of refrigerant circuit	#	2	2	2	2	2	2
Minimum cooling load % (6)	%	10	10	10	10	10	10
Shipping Weight(5)	(kg)	6770	7375	7395	8790	9175	9545
Operating Weight(5)	(kg)	6825	7435	7485	8880	9270	9645

Notes:

- (1) At Evaporator water temperature: 12°C / 7°C - Condenser air temperature 35°C according to EN14511:2013
- (2) At Evaporator water temperature: 6.6°C (44°F) / 12.2°C (54°F) - condenser air temperature 46°C (114.8°F) - FFE=1.76*10⁻⁵ m²•°C/W
- (4) Under 400V/3/50Hz
- (5) Rated Condition without Pump Package
- (6) Percent minimum load can be lowered on demand to local sales office
- (7) Minimum start-up/operation ambient based on a 2.22 m/s (5mph) wind across the condenser
- (8) Maximum ambient operation is for unit at 12°C / 7°C

Electrical & system data are subject to change without notice. Please refer to unit nameplate data

General Data

Figure 10 – Evaporator water pressure drop without Turbulators (SI Unit) sizes 090-205

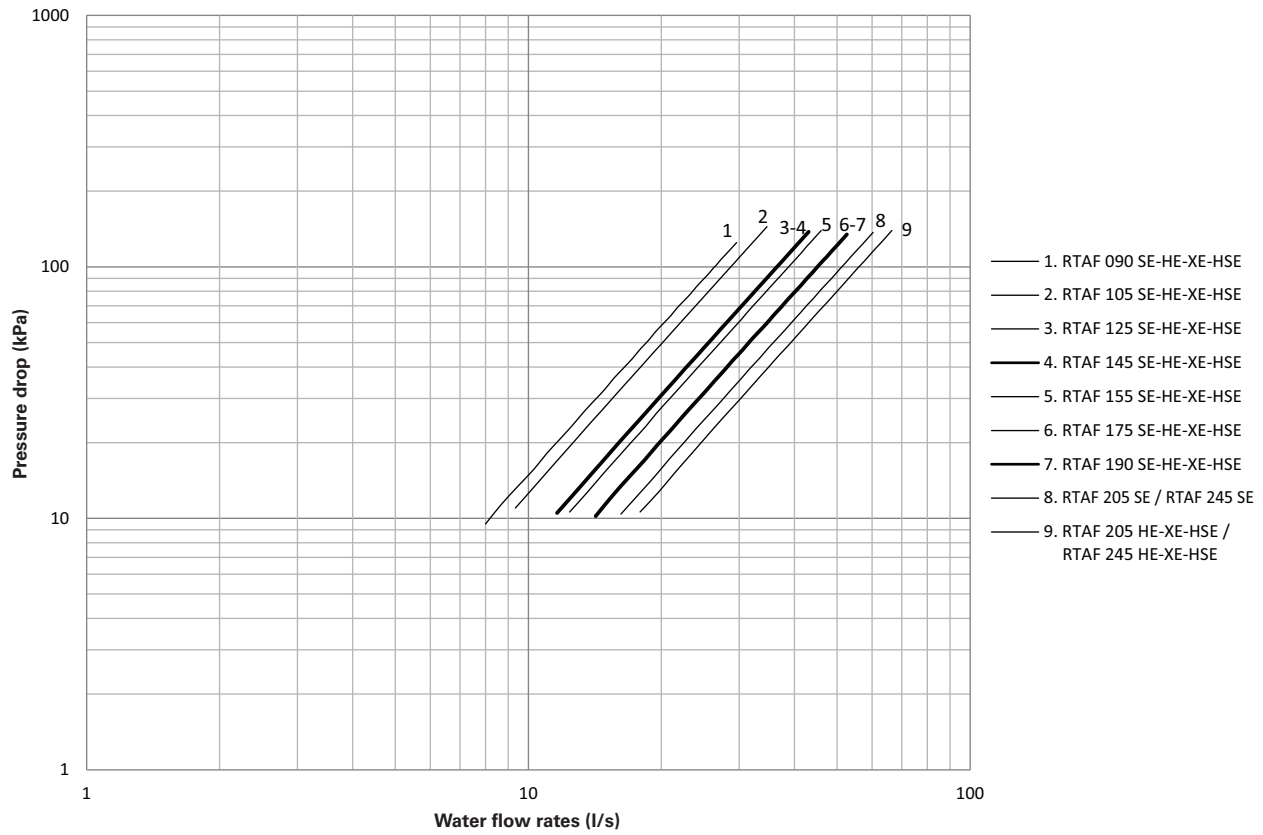
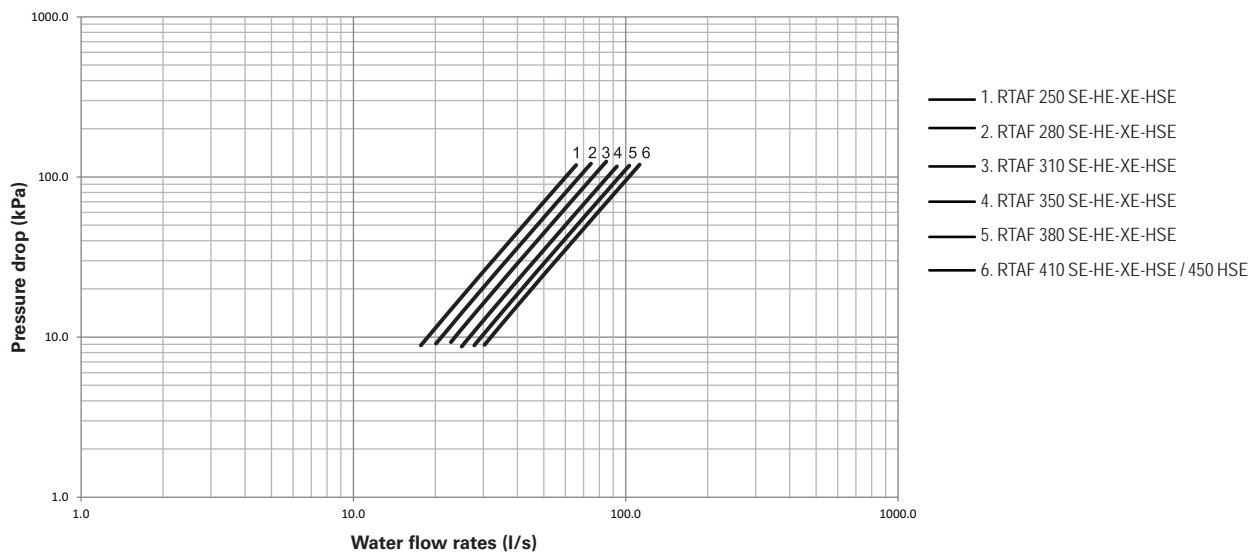

Figure 11 - Evaporator water pressure drop without Turbulators (SI Unit) sizes 250-450



General Data

Figure 12 – Evaporator water pressure drop without Turbulators (SI Unit) sizes 090-205

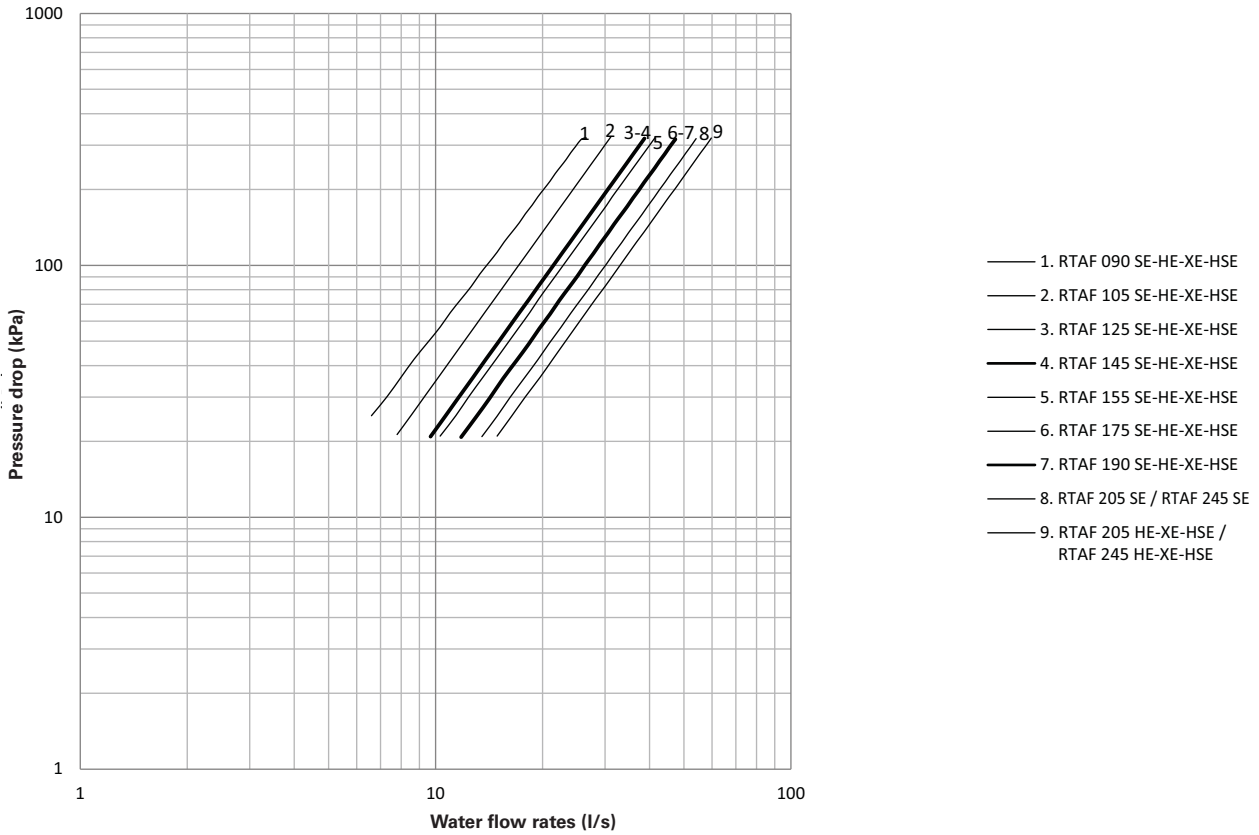
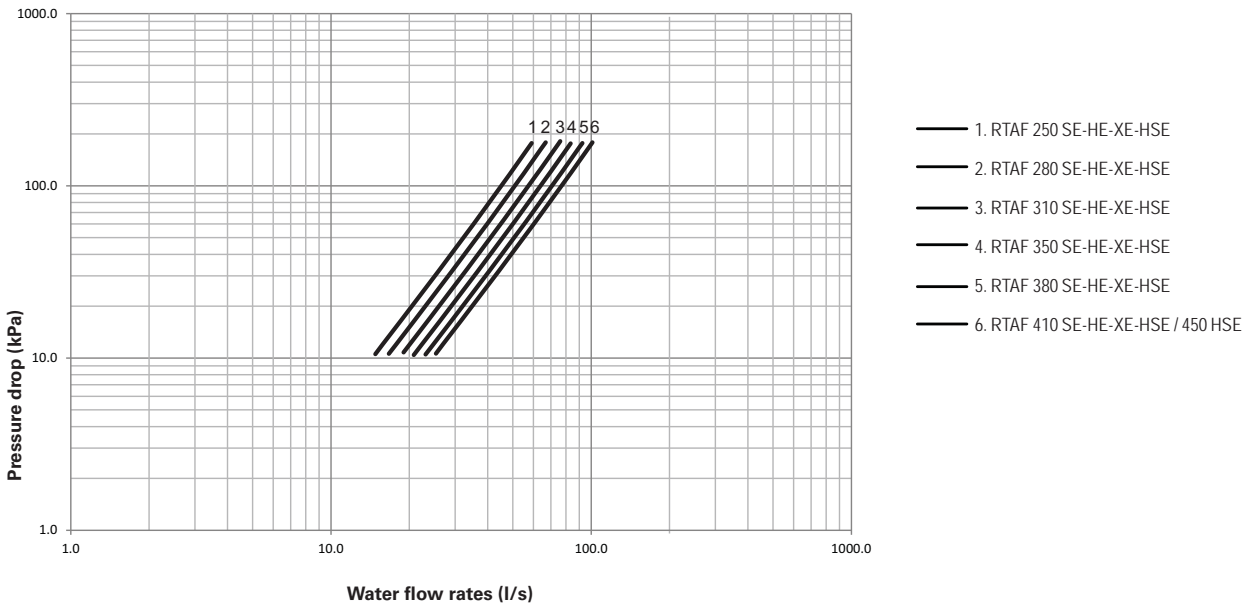

Figure 13 – Evaporator water pressure drop without Turbulators (SI Unit) sizes 250-450



General Data

Figure 14 – Standard head available pressure pump package (Evaporator without Turbulators)

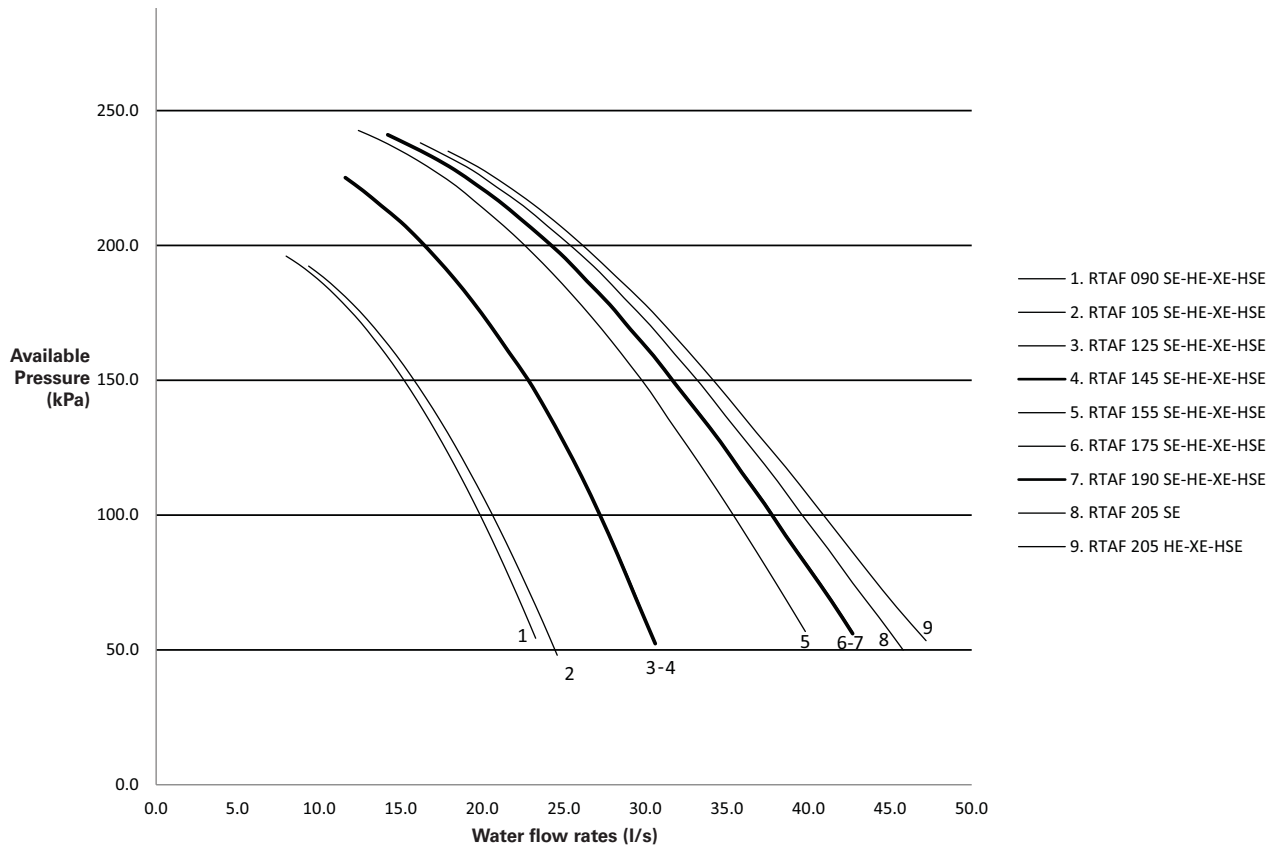
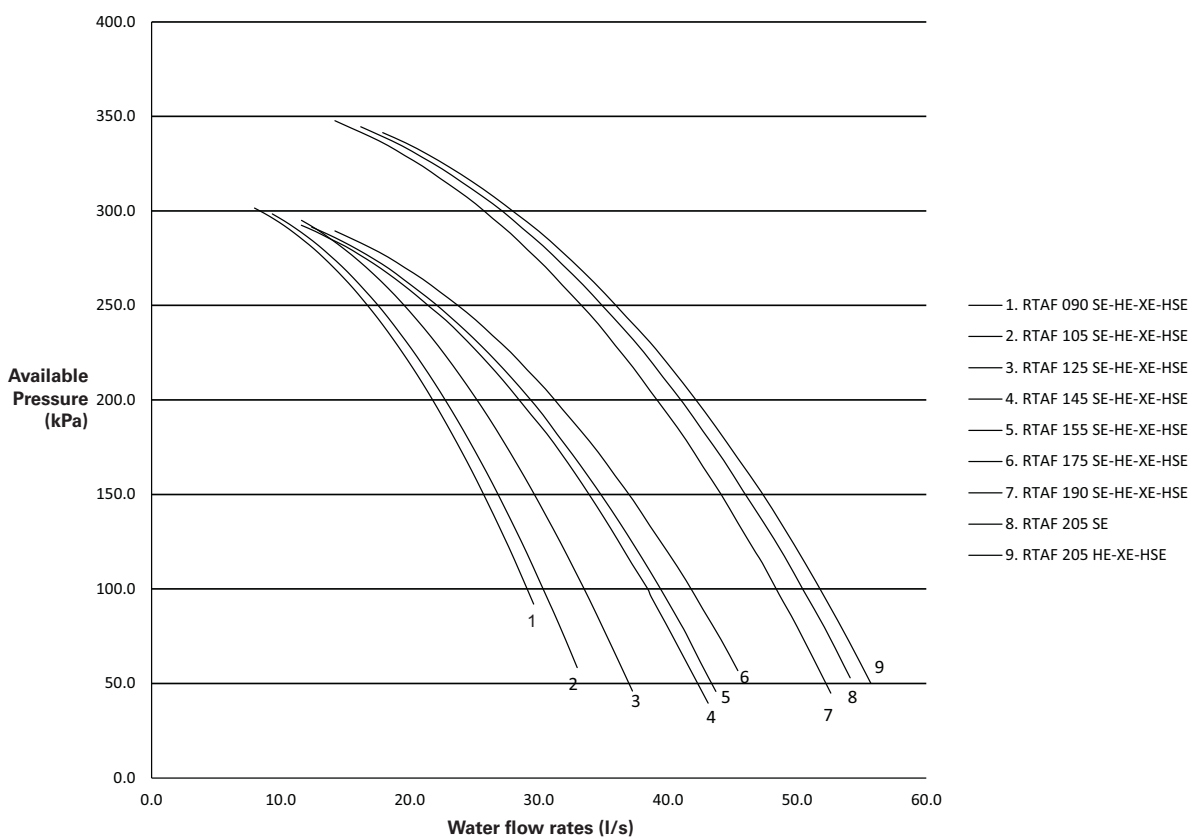

Figure 15 – High head available pressure pump package (Evaporator without Turbulators)



General Data

Figure 16 – Standard head available pressure pump package (Evaporator with Turbulators)

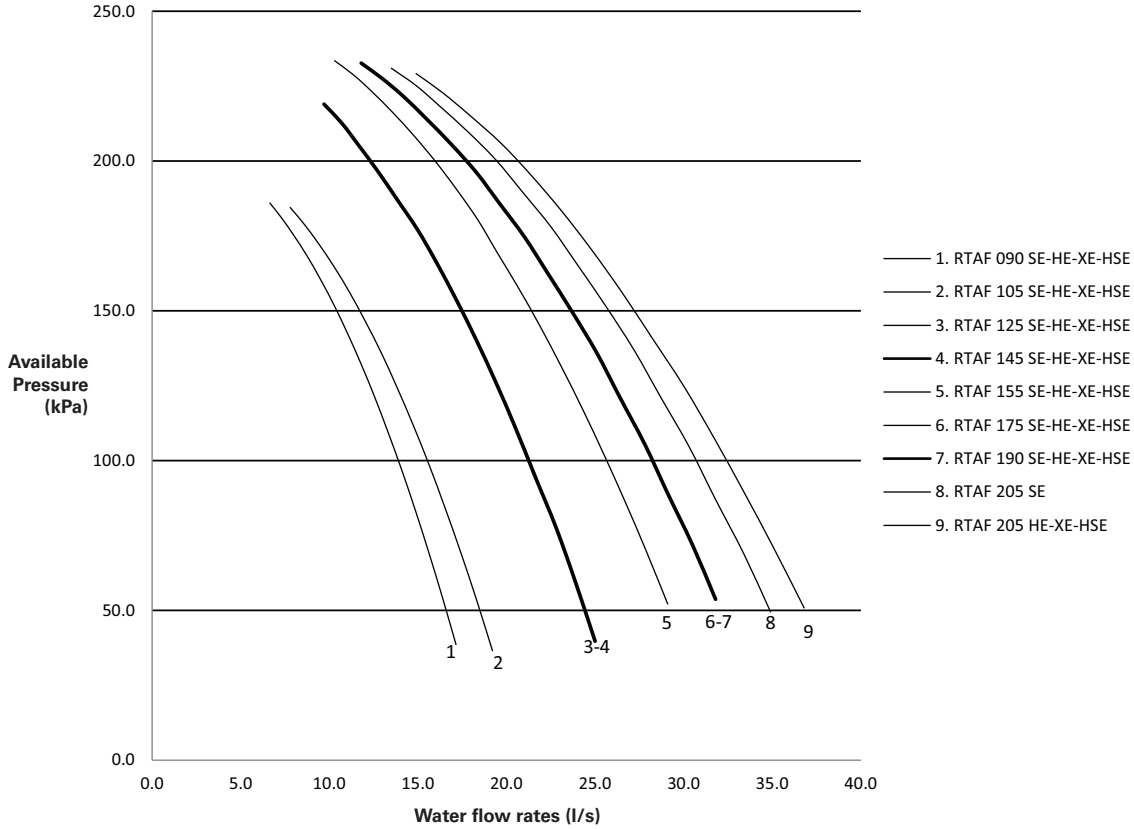
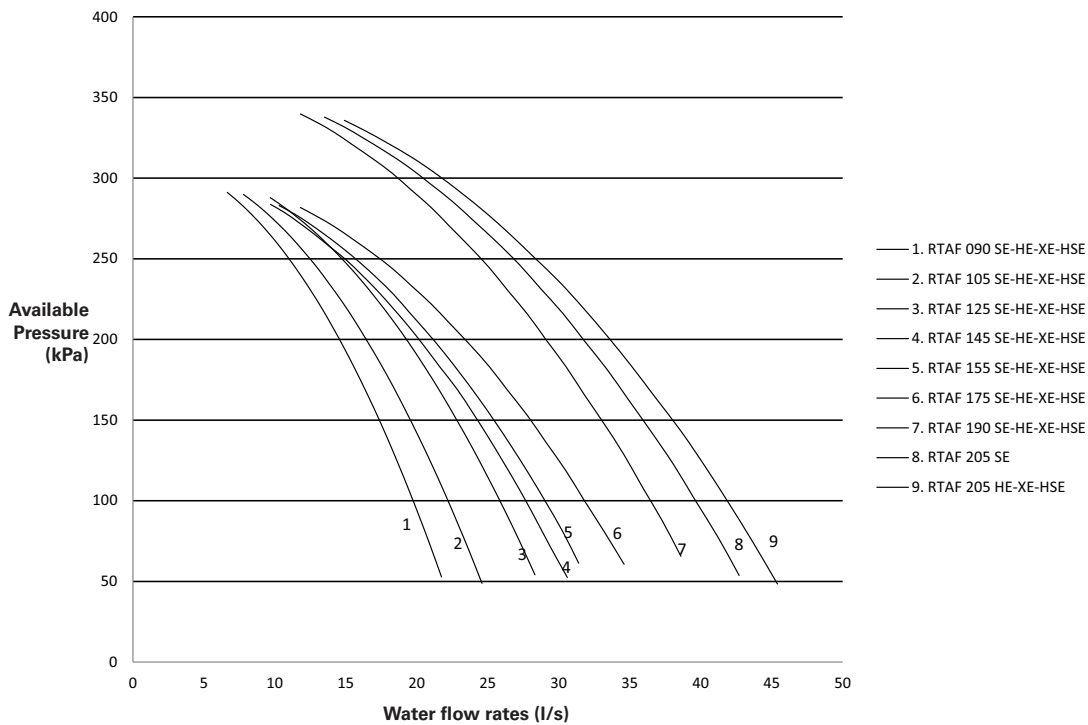

Figure 17 – Pressure pump package (Evaporator with Turbulators)



Hydraulic Module

The hydraulic module includes*:

- Twin water pump: Low pressure or High pressure
- Water strainer to protect the water circuit against fouling
- Expansion vessel and pressure relief valve to protect the water circuit against over pressure
- Thermal insulation for antifreeze protection
- Balancing valve to adjust the water flow
- Drain valve

* Components may differ depending on unit model and size. Contact your local sales office for details.

Figure 18 – Hydraulic module option

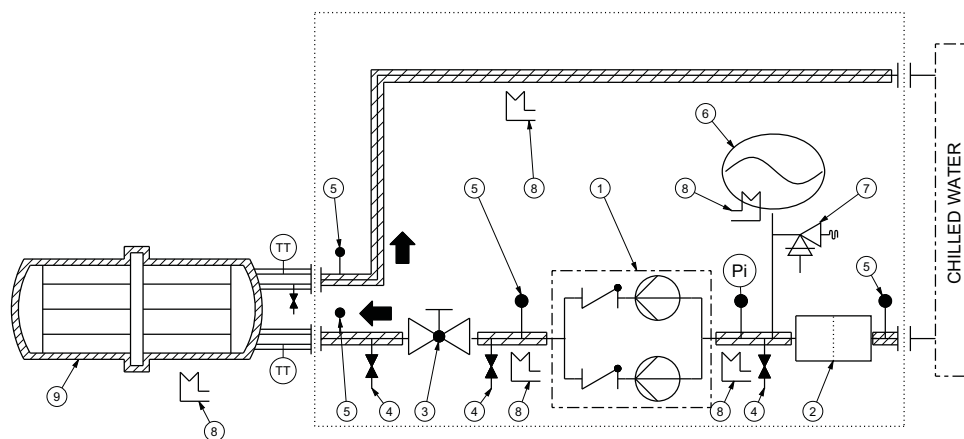

- 1 = Twin centrifugal pump
- 2 = Water strainer
- 3 = Balancing valve
- 4 = Drain valve
- 5 = Valve for pressure point
- 6 = Expansion tank
- 7 = Pressure relief valve
- 8 = Antifreeze protection
- 9 = Evaporator
- Pi = Gauge
- TT = Temperature sensor

Sound Power Levels

Table 19 – Sound power levels in accordance with ISO 9614 - 1996.

Unit RTAF	SE					HE		XE					HSE					HSS				
dB(A) ⁽¹⁾	SN	LN	LN+NNSB	XLN	XLN+NNSB	SN	LN	SN	LN	LN+NNSB	XLN	XLN+NNSB	SN	LN	LN+NNSB	XLN	XLN+NNSB	SN	LN	LN+NNSB	XLN	XLN+NNSB
90	95	92	89	88	85	95	93	94	91	90	88	86	94	91	90	88	86	95	92	89	88	85
105	95	92	89	89	86	95	93	94	91	89	88	86	94	91	89	88	86	95	92	89	89	86
125	95	92	89	89	86	96	93	95	92	90	88	85	95	92	90	88	85	95	92	89	89	86
145	96	93	90	89	86	96	93	96	93	90	89	86	96	93	90	89	86	96	93	90	89	86
155	96	93	90	90	87	97	94	97	94	91	90	87	97	94	91	90	87	96	93	90	90	87
175	97	94	91	90	87	97	94	97	94	91	90	87	97	94	91	90	87	97	94	91	90	87
190	97	94	91	91	88	98	95	98	95	92	91	88	98	95	92	91	88	97	94	91	91	88
205	97	94	91	91	88	98	95	98	95	92	91	88	98	95	92	91	88	97	94	91	91	88
245	-	-	-	-	-	-	-	-	-	-	-	-	104	101	-	97	-	-	-	-	-	-

Table 20 – Sound pressure levels at 10m

Unit RTAF	SE					HE		XE					HSE					HSS				
dB(A) ⁽²⁾	SN	LN	LN+NNSB	XLN	XLN+NNSB	SN	LN	SN	LN	LN+NNSB	XLN	XLN+NNSB	SN	LN	LN+NNSB	XLN	XLN+NNSB	SN	LN	LN+NNSB	XLN	XLN+NNSB
90	63	60	57	56	53	63	61	62	59	56	55	53	62	59	57	55	53	63	60	57	56	53
105	63	60	57	57	54	63	61	62	59	56	55	53	62	59	57	55	53	63	60	57	57	54
125	63	60	57	57	54	64	61	63	60	57	55	53	63	60	57	55	52	63	60	57	57	54
145	64	61	58	56	53	63	60	63	60	57	56	54	63	60	57	56	53	64	61	58	56	53
155	64	61	58	58	55	64	61	64	61	58	57	54	64	61	58	57	54	64	61	58	58	55
175	65	62	59	58	55	64	61	64	61	58	57	54	64	61	58	57	54	65	62	59	58	55
190	64	61	58	58	55	65	62	65	62	59	58	55	65	62	59	58	55	64	61	58	58	55
205	64	61	58	58	55	65	62	65	62	59	58	55	65	62	59	58	55	64	61	58	58	55
245	-	-	-	-	-	-	-	-	-	-	-	-	71	68	-	64	-	-	-	-	-	-

Notes:

At Eurovent conditions: 12/7°C entering/leaving water temperature and 35°C ambient temperature

(1) Value at full load with 1pW Reference Sound Power, according to ISO9614

(2) Average at 10 meters in a free field. This is a non-contractual data, calculated from the above certified sound power level according to the formula $L_p=L_w-10\log S$. This is an averaged value considering the unit as a parallelepipedic box with five exposed face areas.

Table 21 – Sound Power Levels in accordance with ISO 9614-1996

Unit RTAF	SE					HE		XE					HSE					HSS				
dB(A)	SN	LN	LN+NNSB	XLN	XLN+NNSB	SN	LN	SN	LN	LN+NNSB	XLN	XLN+NNSB	SN	LN	LN+NNSB	XLN	XLN+NNSB	SN	LN	LN+NNSB	XLN	XLN+NNSB
250	99	96	94	93	91	99	96	99	96	94	93	91	99	96	95	93	91	99	96	94	93	91
280	100	97	95	94	92	100	97	100	97	95	94	92	100	97	96	94	92	100	97	95	94	92
310	101	98	96	94	92	101	98	101	98	96	95	93	101	98	97	95	93	101	98	96	94	92
350	101	98	96	94	92	101	98	101	98	96	95	93	101	98	97	95	93	101	98	96	94	92
380	101	98	96	95	93	102	98	102	98	96	95	93	102	98	97	95	93	101	98	96	95	93
410	102	99	97	95	93	102	99	102	99	97	95	93	102	99	98	95	93	102	99	97	95	93
415	-	-	-	-	-	-	-	102	100	97	-	-	-	-	-	-	-	-	-	-	-	-
450	-	-	-	-	-	-	-	-	-	-	-	-	107	104	-	103	-	-	-	-	-	-

Table 22 – Sound Pressure Levels at 10 m

Unit RTAF	SE					HE		XE					HSE					HSS				
dB(A)	SN	LN	LN+NNSB	XLN	XLN+NNSB	SN	LN	SN	LN	LN+NNSB	XLN	XLN+NNSB	SN	LN	LN+NNSB	XLN	XLN+NNSB	SN	LN	LN+NNSB	XLN	XLN+NNSB
250	66	63	61	60	58	66	63	66	63	61	60	58	66	63	61	60	-	66	63	61	60	58
280	67	64	62	61	59	67	64	67	64	62	61	59	67	64	62	61	-	67	64	62	61	59
310	68	65	63	61	59	68	65	68	65	63	62	60	68	65	62	62	-	68	65	63	61	59
350	68	65	63	61	59	68	65	68	65	63	62	60	68	65	62	62	-	68	65	63	61	59
380	68	65	63	62	60	69	65	69	65	63	62	60	69	65	62	62	-	68	65	63	62	60
410	69	66	64	62	60	69	66	69	66	63	62	60	69	66	63	62	-	69	66	64	62	60
415	-	-	-	-	-	-	-	70	67	64	-	-	-	-	-	-	-	-	-	-	-	-
450	-	-	-	-	-	-	-	-	-	-	-	-	74	71	-	70	-	-	-	-	-	-

Notes:

At Eurovent conditions: 12/7°C entering/leaving water temperature and 35°C ambient temperature

(1) Value at full load with 1pW Reference Sound Power, according to ISO9614

(2) Average at 10 meters in a free field. This is a non-contractual data, calculated from the above certified sound power level according to the formula $L_p=L_w-10\log S$. This is an averaged value considering the unit as a parallelepipedic box with five exposed face areas.

Controls System

Tracer UC800 Controller

Today's Sintesis chillers offer predictive controls that anticipate and compensate for load changes. Other control strategies made possible with the Tracer UC800 controls are:

Feedforward Adaptive Control

Feedforward is an open-loop, predictive control strategy designed to anticipate and compensate for load changes. It uses evaporator entering-water temperature as an indication of load change.

This allows the controller to respond faster and maintain stable leaving-water temperatures.

Soft Loading

The chiller controller uses soft loading except during manual operation. Large adjustments due to load or setpoint changes are made gradually, preventing the compressor from cycling unnecessarily. It does this by internally filtering the setpoints to avoid reaching the differential-to-stop or the demand limit. Soft loading applies to the leaving chilled-water temperature and demand limit setpoints.

Adaptive Controls

There are many objectives that the controller must meet, but it cannot satisfy more than one objective at a time. Typically, the controllers primary objective is to maintain the evaporator leaving water temperature.

Whenever the controller senses that it can no longer meet its primary objective without triggering a protective shutdown, it focuses on the most critical secondary objective. When the secondary objective is no longer critical, the controller reverts to its primary objective

Rapid Restart

The controller allows the Sintesis chiller to perform a Rapid Restart. A Rapid Restart is performed after a momentary power loss if it occurs during operation. Similarly, if the chiller shuts down on a non-latching diagnostic and the diagnostic later clears itself, a Rapid Restart will be initiated

AdaptiSpeed Control

The speed control is now optimized mathematically and controlled simultaneously. The increased performance of the UC800 Controller allows the chiller to operate longer at higher efficiency, and with greater stability.

Variable-Primary Flow (VPF)

Chilled-water systems that vary the water flow through chiller evaporators have caught the attention of engineers, contractors, building owners, and operators. Varying the water flow reduces the energy consumed by pumps, while having limited effect on the chiller energy consumption. This strategy can be a significant source of energy savings, depending on the application.

TD7 Operator Interface

The standard TD7 display provided with the Trane UC800 controller features a 7" LCD touch-screen, allowing access to all operational inputs and outputs. This is an advanced interface that allows the user to access any important information concerning setpoints, active temperatures, modes, electrical data, pressure, and diagnostics.

Display Features Include:

- Factory-mounted above the control panel door
- UV Resistant touchscreen
- -40°C to 70°C Operating temperature
- IP56 rated
- CE marking
- Emissions: EN55011(Class B)
- Immunity: EN61000(Industrial)
- 7" diagonal
- 800x480 pixels
- TFT LCD @ 600 nits brightness
- 16 bit color graphic display
- Display features:
 - Alarms
 - Reports
 - Chiller settings
 - Display settings
 - Graphing
 - Support for 15 languages

Figure 19 – TD7 operator interface





Controls System

TracerTU Interface

TracerTU (for on-Trane personnel, contact your local Trane office for software) adds a level of sophistication that improves service technician effectiveness and minimizes chiller downtime. The portable PC-based service-tool software, TracerTU, supports service and maintenance tasks. TracerTU serves as a common interface to all Trane® chillers, and will customize itself based on the properties of the chiller with which it is communicating. Thus, the service technician learns only one service interface. The panel bus is easy to troubleshoot using LED sensor verification. Only the defective device is replaced. TracerTU can communicate with individual devices or groups of devices. All chiller status, machine configuration settings, customizable limits, and up to 100 active or historic diagnostics are displayed through the service-tool software interface. LEDs and their respective TracerTU indicators visually confirm the availability of each connected sensor, relay, and actuator.

TracerTU is designed to run on a customer's laptop, connected to the TracerTD7 control panel with a USB cable. Your laptop must meet the following hardware and software requirements:

- 1 GB RAM (minimum)
- 1024 x 768 screen resolution
- CD-ROM drive
- Ethernet 10/100 LAN card
- An available USB 2.0 port
- Microsoft® Windows® XP Professional operation system with Service Pack 3 (SP3) or Windows 7 Enterprise or Professional operating system (32-bit or 64-bit)
- Microsoft .NET Framework 4.0 or later

Note: TracerTU is designed and validated for this minimum laptop configuration. Any variation from this configuration may have different results. Therefore, support for TracerTU is limited to only those laptops with the configuration previously specified.

Figure 20 – Screen TD7 interface

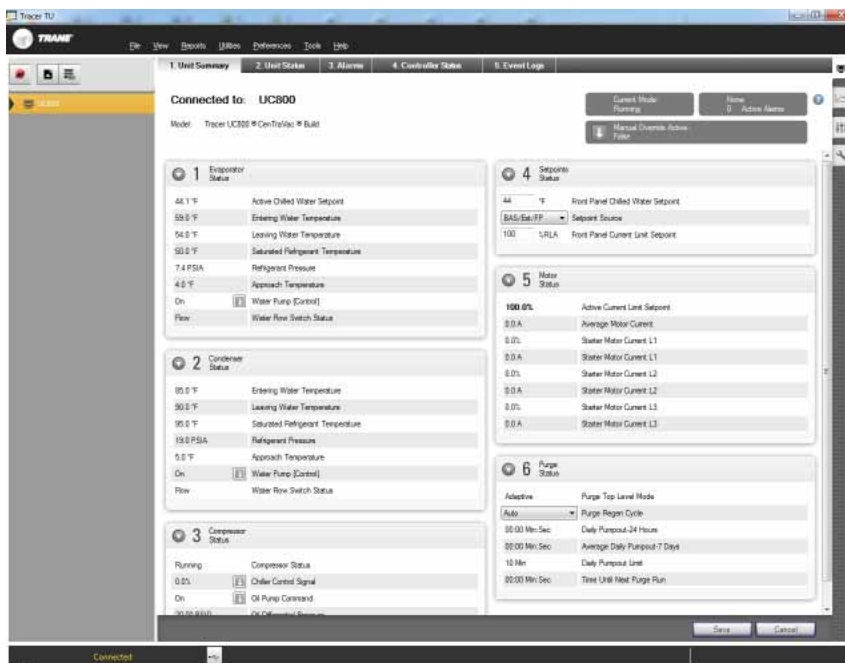

Controls System

System Integration

Stand-Alone Controls

Single chillers installed in applications without a building management system are simple to install and control: only a remote auto/stop for scheduling is required for unit operation. Signals from the chilled-water pump contactor auxiliary, or a flow switch, are wired to the chilled-water flow interlock. Signals from a time clock or some other remote device are wired to the external auto/stop input.

- Auto/Stop-A job-site provided contact closure turns the unit on and off.
- External Interlock-A job-site provided contact opening wired to this input turns the unit off and requires a manual reset of the unit microcomputer. This closure is typically triggered by a job-site provided system such as a fire alarm.

Hardwire Points

Microcomputer controls allow simple interface with other control systems, such as time clocks, building automation systems, and ice storage systems via hardwire points. This means you have the flexibility to meet job requirements while not having to learn a complicated control system. Remote devices are wired from the control panel to provide auxiliary control to a building automation system. Inputs and outputs can be communicated via a typical 4–20 mA electrical signal, an equivalent 2–10 V dc signal, or by utilizing contact closures. This setup has the same features as a stand-alone water chiller, with the possibility of having additional optional features:

- Ice making control.
- External chilled water setpoint, external demand limit setpoint
- Chilled water temperature reset.
- Programmable relays - available outputs are: alarm-latching, alarm-auto reset, general alarm-warning, chiller limit mode, compressor running, and Tracer control.
- **BACnet Interface**
- TracerTD7 control can be configured for BACnet communications at the factory or in the field. This enables the chiller controller to communicate on a BACnet MS/TP network. Chiller setpoints, operating modes, alarms, and status can be monitored and controlled through BACnet. TracerTD7 controls conforms to the BACnet B-ASC profile as defined by ASHRAE 135-2004.
- LonTalk Communications Interface (LCI-C)

- The optional LonTalk® Communications Interface for Chillers (LCI-C) is available factory or field installed. It is an integrated communication board that enables the chiller controller to communicate over a LonTalk network. The LCI-C is capable of controlling and monitoring chiller setpoints, operating modes, alarms, and status. The Trane LCI-C provides additional points beyond the standard LONMARK® defined chiller profile to extend interoperability and support a broader range of system applications. These added points are referred to as open extensions. The LCI-C is certified to the LONMARK Chiller Controller Functional Profile 8040 version 1.0, and follows LonTalk FTT-10A free topology communications.

Modbus Interface TracerTD7 control can be configured for Modbus communications at the factory or in the field. This enables the chiller controller to communicate as a slave device on a Modbus network. Chiller setpoints, operating modes, alarms, and status can be monitored and controlled by a Modbus master device.

Tracer Summit

The chiller plant control capabilities of the Trane Tracer Summit™ building automation system are unequalled in the industry. Trane's depth of experience in chillers and controls makes us a well-qualified choice for automation of chiller plants using air-cooled RTAF chillers. Our chiller plant automation software is fully pre-engineered and tested.

Required features:

- LonTalk/Tracer Summit Interface (selectable option with chiller)
- Building Control Unit (external device required)
- Sequences starting of chillers to optimize the overall chiller plant energy efficiency
 - Individual chillers operate as base, peak, or swing based on capacity and efficiency
 - Automatically rotates individual chiller operation to equalize runtime and wear between chillers
 - Evaluates and selects the lowest energy consumption alternative from an overall system perspective.
- Regulatory Compliance Documentation
- Gathers information and generates the reports mandated in ASHRAE Guideline 3.
- Easy Operation and Maintenance
- Remote monitoring and control
- Displays both current operation conditions and scheduled automated control actions
- Concise reports assist in planning for preventative maintenance and verifying performance

Alarm notification and diagnostic messages aid in quick and accurate troubleshooting.



Controls System

Tracer SC

The Tracer SC™ system controller acts as the central coordinator for all individual equipment devices on a Tracer building automation system. The Tracer SC scans all unit controllers to update information and coordinate building control, including building subsystems such as VAV and chiller water systems. With this system option, the full breadth of Trane's HVAC and controls experience are applied to offer solutions to many facility issues. The LAN allows building operators to manage these varied components as one system from any personal computer with web access.

The benefits of this system are:

- Improved usability with automatic data collection, enhanced data logging, easier to create graphics, simpler navigation, pre-programmed scheduling, reporting, and alarm logs.
- Flexible technology allows for system sizes from 30-120 unit controllers with any combination of LonTalk or BACnet unit controllers.
- LEED certification through site commissioning report, energy data collection measurement, optimizing energy performance, and maintaining indoor air quality.

Energy savings programs include: fan pressure optimization, ventilation reset, and chiller plant control (adds and subtracts chillers to meet cooling loads).

Building Automation and Chiller Plant Control

The UC800 controller can communicate with Trane Tracer Summit, Tracer SC and Tracer ES building automation systems, which include pre-engineered and flexible control for chiller plants. These building automation systems can control the operation of the complete installation: chillers, pumps, isolating valves, air handlers, and terminal units.

Trane can undertake full responsibility for optimized automation and energy management for the entire chiller plant.

The main functions are:

- **Chiller sequencing:** equalizes the number of running hours of the chillers. Different control strategies are available depending on the configuration of the installation.
- **Control of the auxiliaries:** includes input/output modules to control the operation of the various auxiliary equipment (water pumps, valves, etc.).
- **Time-of-day scheduling:** allows the end user to define the occupancy period, for example: time of the day, holiday periods and exception schedules.
- **Optimization of the installation start/stop time:** based on the programmed schedule of occupancy and the historical temperature records. Tracer Summit and Tracer SC calculate the optimal start/stop time of the installation to get the best compromise between energy savings and comfort of the occupants.

- **Soft loading:** the soft loading function minimizes the number of chillers that are operated to satisfy a large chilled-water-loop pull down, thus preventing an overshoot of the actual capacity required. Unnecessary starts are avoided and the peak current demand is lowered.
- **Communication capabilities:** local, through a PC workstation keyboard. Tracer Summit and Tracer SC can be programmed to send messages to other local or remote workstations and or a pager in the following cases:
 - Analog parameter exceeding a programmed value
 - Maintenance warning
 - Component failure alarm
 - Critical alarm messages. In this latter case, the message is displayed until the operator acknowledges the receipt of the information. From the remote station it is also possible to access and modify the chiller plants control parameters.

Remote communication through a modem: as an option, a modem can be connected to communicate the plant operation parameters through voice grade phone lines.

A remote terminal is a PC workstation equipped with a modem and software to display the remote plant parameters.

Integrated Comfort System (ICS)

The onboard Tracer chiller controller is designed to be able to communicate with a wide range of building automation systems. In order to take full advantage of chiller's capabilities, incorporate your chiller into a Tracer Summit or Tracer SC building automation system. But the benefits do not stop at the chiller plant. At Trane, we realize that all the energy used in your cooling system is important. That is why we worked closely with other equipment manufacturers to predict the energy required by the entire system. We used this information to create patented control logic for optimizing HVAC system efficiency. The building owners challenge is to tie components and applications expertise into a single reliable system that provides maximum comfort, control, and efficiency. Trane Integrated Comfort systems (ICS) are a concept that combines system components, controls, and engineering applications expertise into a single, logical, and efficient system. These advanced controls are fully commissioned and available on every piece of Trane® equipment, from the largest chiller to the smallest VAV box. As a manufacturer, only Trane offers this universe of equipment, controls, and factory installation and verification.

Electrical Data

Table 23 – Electrical Data RTAF 090 - 205 / Standard Efficiency

Unit Wiring 400 / 3 / 50						
Unit Size	Number of Power Connections	Maximum Amps (1)	Starting Amps (2)	Power Factor (3)	Disconnect Switch Size	Short Circuit Rating (kA)
Standard noise level / Low noise level / Extra low noise level						
090	1	229	276	0.87	400	35.0
105	1	267	331	0.86	400	35.0
125	1	317	442	0.85	500	35.0
145	1	374	499	0.85	630	35.0
155	1	409	562	0.85	630	35.0
175	1	448	573	0.85	630	35.0
190	1	491	644	0.86	800	35.0
205	1	530	644	0.86	800	35.0

Table 24 – Electrical Data RTAF 090 - 205 / High Efficiency

Unit Wiring 400 / 3 / 50						
Unit Size	Number of Power Connections	Maximum Amps (1)	Starting Amps (2)	Power Factor (3)	Disconnect Switch Size	Short Circuit Rating (kA)
Standard noise level / Low noise level / Extra low noise level						
090	1	236	283	0.87	400	35.0
105	1	274	338	0.86	400	35.0
125	1	324	449	0.85	500	35.0
145	1	382	507	0.84	630	35.0
155	1	417	570	0.85	630	35.0
175	1	456	581	0.85	630	35.0
190	1	499	652	0.85	800	35.0
205	1	538	652	0.85	800	35.0

Table 25 – Electrical Data RTAF 090 - 205 / Extra Efficiency

Unit Wiring 400 / 3 / 50						
Unit Size	Number of Power Connections	Maximum Amps (1)	Starting Amps (2)	Power Factor (3)	Disconnect Switch Size	Short Circuit Rating (kA)
Standard noise level / Low noise level / Extra low noise level						
090	1	236	283	0.91	400	35.0
105	1	274	338	0.89	400	35.0
125	1	324	449	0.88	500	35.0
145	1	382	507	0.88	630	35.0
155	1	417	570	0.88	630	35.0
175	1	456	581	0.88	800	35.0
190	1	499	652	0.88	800	35.0
205	1	538	652	0.88	800	35.0

Table 26 – Electrical Data RTAF 090 - 205 / High Seasonal Efficiency

Unit Wiring 400 / 3 / 50						
Unit Size	Number of Power Connections	Maximum Amps (1)	Starting Amps (2)	Power Factor (3)	Disconnect Switch Size	Short Circuit Rating (kA)
Standard noise level / Low noise level / Extra low noise level						
090	1	229	229	0.95	400	35.0
105	1	262	262	0.95	400	35.0
125	1	305	305	0.95	500	35.0
145	1	357	357	0.95	630	35.0
155	1	392	392	0.95	630	35.0
175	1	427	427	0.95	800	35.0
190	1	470	470	0.95	800	35.0
205	1	505	505	0.95	800	35.0
245	1	530	530	0.95	800	35.0

Notes:

1. Maximum Compressors FLA + All Fans FLA + Control Amps
2. Starting amps of the largest compressor plus RLA of second compressor plus RLA of all fans and control amps
3. Compressor Power Factor



Electrical Data

Table 27 – Electrical Data RTAF 090 - 205 / High Seasonal Short

Unit wiring 400/3/50						
Unit Size	Number of Power Connections	Maximum Amps (1)	Starting Amps (2)	Power Factor (3)	Disconnect Switch Size	Short Circuit Rating (kA)
Standard noise level / Low noise level / Extra low noise level						
090	1	221	221	0.95	400	35
105	1	254	254	0.95	400	35
125	1	298	298	0.95	500	35
145	1	349	349	0.95	630	35
155	1	384	384	0.95	630	35
175	1	419	419	0.95	800	35
190	1	462	462	0.95	800	35
205	1	497	497	0.95	800	35

Table 28 – Electrical Data RTAF 250 - 410 / Standard Efficiency

Unit wiring 400/3/50						
Unit Size	Number of Power Connections	Maximum Amps (A) (1)	Starting Amps (A) (2)	Power Factor	Disconnect Switch Size (A)	Short Circuit Rating (kA)
Standard noise level / Low noise level / Extra low noise level						
250	1	626	779	0.86	1250	35
280	1	708	861	0.86	1250	35
310	1	786	900	0.86	1250	35
350	1	878	1031	0.86	1250	35
380	1	964	1117	0.86	1250	35
410	1	1049	1163	0.86	1250	35
Standard Efficiency Extra Low Noise or Low Ambient						
250	1	626	779	0.88	1250	35
280	1	708	861	0.88	1250	35
310	1	786	900	0.88	1250	35
350	1	878	1031	0.88	1250	35
380	1	964	1117	0.88	1250	35
410	1	1049	1163	0.88	1250	35

Table 29 – Electrical Data RTAF 250 - 410 / High Efficiency

Unit wiring 400/3/50						
Unit Size	Number of Power Connections	Maximum Amps (A) (1)	Starting Amps (A) (2)	Power Factor	Disconnect Switch Size (A)	Short Circuit Rating (kA)
High Efficiency Standard Noise / Low Noise and Standard or High Ambient						
250	1	634	787	0.85	1250	35
280	1	716	869	0.86	1250	35
310	1	802	947	0.86	1250	35
350	1	893	1046	0.86	1250	35
380	1	979	1132	0.86	1250	35
410	1	1057	1202	0.86	1250	35

Table 30 – Electrical Data RTAF 250 - 410 / Extra Efficiency

Unit wiring 400/3/50						
Unit Size	Number of Power Connections	Maximum Amps (A) (1)	Starting Amps (A) (2)	Power Factor	Disconnect Switch Size (A)	Short Circuit Rating (kA)
Extra Efficiency Standard Noise / Low Noise / Extra Low Noise						
250	1	634	787	0.88	1250	35
280	1	716	869	0.88	1250	35
310	1	802	916	0.88	1250	35
350	1	893	1046	0.88	1250	35
380	1	979	1132	0.88	1250	35
410	1	1057	1171	0.88	1250	35
415	1	1057	1202	0.88	1250	35

Notes:

1. Maximum Compressors FLA + All Fans FLA + Control Amps
2. Starting amps of the largest compressor plus RLA of second compressor plus RLA of all fans and control amps
3. Compressor Power Factor

Electrical Data

Table 31 – Electrical Data RTAF 250 - 410 / High Seasonal Efficiency

Unit wiring 400/3/50						
Unit Size	Number of Power Connections	Maximum Amps (A) (1)	Starting Amps (2) (A)	Power Factor	Disconnect Switch Size (A)	Short Circuit Rating (kA)
High Seasonal Efficiency Standard Noise / Low Noise / Extra Low Noise						
250	1	608	761	0.93	1250	35
280	1	690	804	0.92	1250	35
310	1	769	883	0.93	1250	35
350	1	868	1021	0.92	1250	35
380	1	953	1067	0.91	1250	35
410	1	1024	1138	0.91	1250	35
450	1	1054	1168	0.91	1600	35

Table 32 – Electrical Data RTAF 250 - 410 / High Seasonal Efficiency Short

Unit wiring 400/3/50						
Unit Size	Number of Power Connections	Maximum Amps (A) (1)	Starting Amps (2) (A)	Power Factor	Disconnect Switch Size (A)	Short Circuit Rating (kA)
HSS Standard Noise / Low Noise / Extra Low Noise						
250	1	601	754	0.92	1250	35
280	1	682	796	0.92	1250	35
310	1	753	867	0.92	1250	35
350	1	852	1005	0.91	1250	35
380	1	938	1052	0.91	1250	35
410	1	1017	1131	0.91	1250	35

Table 33 – Fan Motor and Control Circuit Data - RTAF 090 - 205 / Standard Efficiency

Fan (Each)						Control		Evaporator
Unit Size	Qty	kW (1)	kW (2)	FLA (1)	FLA (2)	kW	A	Heater kW
Standard noise level / Low noise level								
090	8	1.85	1.95	3.0	4.0	1.8	3.2	1.6
105	8	1.85	1.95	3.0	4.0	1.8	3.2	1.6
125	8	1.85	1.95	3.0	4.0	1.8	3.2	1.6
145	10	1.85	1.95	3.0	4.0	1.8	3.2	1.6
155	10	1.85	1.95	3.0	4.0	1.8	3.2	1.6
175	10	1.85	1.95	3.0	4.0	1.8	3.2	2.0
190	12	1.85	1.95	3.0	4.0	1.8	3.2	2.0
205	12	1.85	1.95	3.0	4.0	1.8	3.2	2.0
Extra low noise level								
090	8	1.95	1.95	4.0	4.0	1.8	3.2	1.6
105	8	1.95	1.95	4.0	4.0	1.8	3.2	1.6
125	8	1.95	1.95	4.0	4.0	1.8	3.2	1.6
145	10	1.95	1.95	4.0	4.0	1.8	3.2	1.6
155	10	1.95	1.95	4.0	4.0	1.8	3.2	1.6
175	10	1.95	1.95	4.0	4.0	1.8	3.2	2.0
190	12	1.95	1.95	4.0	4.0	1.8	3.2	2.0
205	12	1.95	1.95	4.0	4.0	1.8	3.2	2.0

Notes:

1. Max power input per fan for standard and high ambient
2. Low ambient is not available with high efficiency units
3. Maximum FLA per fan for standard and high ambient
4. Compressor maximum amps under 400/3/50Hz
5. Compressor start up amps under 400/3/50Hz



Electrical Data

Table 34 – Fan Motor and Control Circuit Data - RTAF 090 - 205 / High Efficiency

Fan (Each)						Control		Evaporator
Unit Size	Qty	kW (1)	kW (2)	FLA (1)	FLA (2)	kW	A	Heater kW
Standard noise level / Low noise level								
090	10	1.85	-	3.0	-	1.8	3.2	1.6
105	10	1.85	-	3.0	-	1.8	3.2	1.6
125	10	1.85	-	3.0	-	1.8	3.2	1.6
145	12	1.85	-	3.0	-	1.8	3.2	1.6
155	12	1.85	-	3.0	-	1.8	3.2	1.6
175	12	1.85	-	3.0	-	1.8	3.2	2.0
190	14	1.85	-	3.0	-	1.8	3.2	2.0
205	14	1.85	-	3.0	-	1.8	3.2	2.0

Table 35 – Fan Motor and Control circuit data - RTAF 090 - 205 / Extra Efficiency

Fan (Each)						Control		Evaporator
Unit Size	Qty	kW (1)	kW (2)	FLA (1)	FLA (2)	kW	A	Heater kW
Standard noise level / Low noise level								
090	10	1.95	1.95	4.0	4.0	1.8	3.2	1.6
105	10	1.95	1.95	4.0	4.0	1.8	3.2	1.6
125	10	1.95	1.95	4.0	4.0	1.8	3.2	1.6
145	12	1.95	1.95	4.0	4.0	1.8	3.2	1.6
155	12	1.95	1.95	4.0	4.0	1.8	3.2	1.6
175	12	1.95	1.95	4.0	4.0	1.8	3.2	2.0
190	14	1.95	1.95	4.0	4.0	1.8	3.2	2.0
205	14	1.95	1.95	4.0	4.0	1.8	3.2	2.0

Table 36 – Fan Motor and Control circuit data - RTAF 090 - 205 / High Seasonal Efficiency

Fan (Each)						Control		Evaporator
Unit Size	Qty	kW (1)	kW (2)	FLA (1)	FLA (2)	kW	A	Heater kW
Standard noise level / Low noise level								
090	10	1.95	1.95	4.0	4.0	1.8	3.2	1.6
105	10	1.95	1.95	4.0	4.0	1.8	3.2	1.6
125	10	1.95	1.95	4.0	4.0	1.8	3.2	1.6
145	12	1.95	1.95	4.0	4.0	1.8	3.2	1.6
155	12	1.95	1.95	4.0	4.0	1.8	3.2	1.6
175	12	1.95	1.95	4.0	4.0	1.8	3.2	2.0
190	14	1.95	1.95	4.0	4.0	1.8	3.2	2.0
205	14	1.95	1.95	4.0	4.0	1.8	3.2	2.0
245	14	1.95	1.95	4.0	4.0	1.8	3.2	2.0

Table 37 – Fan Motor and Control circuit data - RTAF 090 - 205 / High Seasonal Short

Fan (Each)						Control		Evaporator
Unit Size	Qty	kW (1)	kW (2)	FLA (1)	FLA (2)	kW	A	Heater kW
Standard noise level / Low noise level								
90	8	1.95	1.95	4.0	4.0	1.8	3.2	1.6
105	8	1.95	1.95	4.0	4.0	1.8	3.2	1.6
125	8	1.95	1.95	4.0	4.0	1.8	3.2	1.6
145	10	1.95	1.95	4.0	4.0	1.8	3.2	1.6
155	10	1.95	1.95	4.0	4.0	1.8	3.2	1.6
175	10	1.95	1.95	4.0	4.0	1.8	3.2	2.0
190	12	1.95	1.95	4.0	4.0	1.8	3.2	2.0
205	12	1.95	1.95	4.0	4.0	1.8	3.2	2.0

Notes:

1. Max power input per fan for standard and high ambient
2. Max power input per fan for low ambient
3. Maximum FLA per fan for standard and high ambient and low ambient
4. Compressor maximum amps under 400/3/50
5. Compressor start up amps under 400/3/50

Electrical Data

Table 38 – Fan Motor and Control circuit data - RTAF 250 - 410 / Standard Efficiency

Fan (Each)						Control		Evaporator
Unit Size	Qty	kW (1)	kW (2)	FLA (1)	FLA (2)	kW	A	Heater kW
Standard noise level / Low noise level								
250	14	1.85	1.95	3.0	4.0	1.8	3.2	2.2
280	16	1.85	1.95	3.0	4.0	1.8	3.2	2.2
310	16	1.85	1.95	3.0	4.0	1.8	3.2	2.2
350	18	1.85	1.95	3.0	4.0	1.8	3.2	2.4
380	20	1.85	1.95	3.0	4.0	1.8	3.2	2.4
410	22	1.85	1.95	3.0	4.0	1.8	3.2	2.4
Extra low noise level								
250	14	1.95	1.95	4.0	4.0	1.8	3.2	2.2
280	16	1.95	1.95	4.0	4.0	1.8	3.2	2.2
310	16	1.95	1.95	4.0	4.0	1.8	3.2	2.2
350	18	1.95	1.95	4.0	4.0	1.8	3.2	2.4
380	20	1.95	1.95	4.0	4.0	1.8	3.2	2.4
410	22	1.95	1.95	4.0	4.0	1.8	3.2	2.4

Table 39 – Fan Motor and Control circuit data - RTAF 250 - 410 / High Efficiency

Fan (Each)						Control		Evaporator
Unit Size	Qty	kW (1)	kW (2)	FLA (1)	FLA (2)	kW	A	Heater kW
Standard noise level / Low noise level								
250	14	1.85	-	3.0	-	1.8	3.2	2.2
280	16	1.85	-	3.0	-	1.8	3.2	2.2
310	16	1.85	-	3.0	-	1.8	3.2	2.2
350	18	1.85	-	3.0	-	1.8	3.2	2.4
380	20	1.85	-	3.0	-	1.8	3.2	2.4
410	22	1.85	-	3.0	-	1.8	3.2	2.4

Table 40 – Fan Motor and Control circuit data - RTAF 250 - 410 / Extra Efficiency

Fan (Each)						Control		Evaporator
Unit Size	Qty	kW (1)	kW (2)	FLA (1)	FLA (2)	kW	A	Heater kW
Standard noise level / Low noise level								
250	14	1.95	1.95	4.0	4.0	1.8	3.2	2.2
280	16	1.95	1.95	4.0	4.0	1.8	3.2	2.2
310	16	1.95	1.95	4.0	4.0	1.8	3.2	2.2
350	18	1.95	1.95	4.0	4.0	1.8	3.2	2.4
380	20	1.95	1.95	4.0	4.0	1.8	3.2	2.4
410	22	1.95	1.95	4.0	4.0	1.8	3.2	2.4
415		1.95	1.95	4.0	4.0	1.8	3.2	2.4

Notes:

1. Max power input per fan for standard and high ambient
2. Max power input per fan for low ambient
3. Maximum FLA per fan for standard and high ambient and low ambient

Electrical Data

Table 41 – Fan Motor and Control circuit data - RTAF 250 - 410 / High Seasonal Efficiency

Fan (Each)						Control		Evaporator
Unit Size	Qty	kW (1)	kW (2)	FLA (1)	FLA (2)	kW	A	Heater kW
Standard noise level / Low noise level								
250	16	1.95	1.95	4	4	1.8	3.2	2.2
280	18	1.95	1.95	4	4	1.8	3.2	2.2
310	20	1.95	1.95	4	4	1.8	3.2	2.2
350	22	1.95	1.95	4	4	1.8	3.2	2.4
380	24	1.95	1.95	4	4	1.8	3.2	2.4
410	24	1.95	1.95	4	4	1.8	3.2	2.4
450	24	1.95	1.95	4	4	1.8	3.2	2.4

Notes:

1. Max power input per fan for standard and high ambient
2. Max power input per fan for low ambient
3. Maximum FLA per fan for standard and high ambient and low ambient

Table 42 – Fan Motor and Control circuit data - RTAF 250 - 410 / High Seasonal Efficiency Short

Fan (Each)						Control		Evaporator
Unit Size	Qty	kW (1)	kW (2)	FLA (1)	FLA (2)	kW	A	Heater kW
Standard noise level / Low noise level								
250	14	1.95	1.95	4	4	1.8	3.2	2.2
280	16	1.95	1.95	4	4	1.8	3.2	2.2
310	16	1.95	1.95	4	4	1.8	3.2	2.2
350	18	1.95	1.95	4	4	1.8	3.2	2.4
380	20	1.95	1.95	4	4	1.8	3.2	2.4
410	22	1.95	1.95	4	4	1.8	3.2	2.4

Electrical Data

Table 43 – Compressor data / RTAF 090-205 Standard Efficiency

Compressor Data						Control Circuit Data
RTAF	Quantity	Maximum Amps (4)		Starting Amps (5)		Disconnect switch Option
Size		Cmpr 1	Cmpr 2	Cmpr 1	Cmpr 2	Power Cable Cross section
Standard Efficiency / High efficiency						
90	2	97	97	144	144	240
105	2	116	116	180	180	240
125	2	166	116	291	180	240
145	2	166	166	291	291	2x300
155	2	201	166	354	291	2x300
175	2	240	166	354	291	2x300
190	2	240	201	354	354	2x300
205	2	240	240	354	354	2x300

Table 44 – Compressor data / RTAF 090-205 Extra Efficiency and High Seasonal Efficiency

Compressor Data						Control Circuit Data
RTAF	Quantity	Maximum Amps (4)		Starting Amps (5)		Disconnect switch Option
Size		Cmpr 1	Cmpr 2	Cmpr 1	Cmpr 2	Power Cable Cross section
Extra Efficiency						
90	2	97	97	144	144	240
105	2	116	116	180	180	240
125	2	166	116	291	180	240
145	2	166	166	291	291	2x300
155	2	201	166	354	291	2x300
175	2	240	166	354	291	2x300
190	2	240	201	354	354	2x300
205	2	240	240	354	354	2x300
High Seasonal Efficiency						
90	2	93	93	93	93	240
105	2	110	110	110	110	240
125	2	153	110	153	110	240
145	2	153	153	153	153	2x300
155	2	188	153	188	153	2x300
175	2	224	153	224	153	2x300
190	2	224	188	224	188	2x300
205	2	224	224	224	224	2x300
245	2	236	236	236	236	2x300

Table 45 – Compressor data / RTAF 090-205 High Seasonal Short Efficiency

Compressor Data						Control Circuit Data
RTAF	Quantity	Maximum Amps (4)		Starting Amps (5)		Disconnect switch Option
Size		Cmpr 1	Cmpr 2	Cmpr 1	Cmpr 2	Power Cable Cross section
Extra Efficiency						
90		93	93	93	93	240
105		110	110	110	110	240
125		153	110	153	110	240
145		153	153	153	153	2x300
155		188	153	188	153	2x300
175		224	153	224	153	2x300
190		224	188	224	188	2x300
205		224	224	224	224	2x300

Notes:

1. Max power input per fan for standard and high ambient
2. Max power input per fan for low ambient
3. Maximum FLA per fan for standard and high ambient and low ambient
4. Compressor maximum amps under 400/3/50
5. Compressor start up amps under 400/3/50

Electrical Data

Table 46 – Compressor data / RTAF 250-410

Compressor Data										
RTAF	Quantity	Maximum Amps (4)				Starting Amps (5)				Disconnect switch Option
		Cmpr 1	Cmpr 2	Cmpr 3	Cmpr 4	Cmpr 1	Cmpr 2	Cmpr 3	Cmpr 4	Power Cable Cross section
Size										Max (mm ²)
Standard Efficiency										
250	3	201	201	166	0	354	354	291	0	4*300
280	3	201	240	201	0	354	354	354	0	4*300
310	3	240	240	240	0	354	354	354	0	4*300
350	4	201	201	201	201	354	354	354	354	4*300
380	4	201	240	201	240	354	354	354	354	4*300
410	4	240	240	240	240	354	354	354	354	4*300
High Efficiency										
250	3	201	201	166	0	354	354	291	0	4*300
280	3	201	240	201	0	354	385	354	0	4*300
310	3	240	240	240	0	385	385	385	0	4*300
350	4	201	201	201	201	354	354	354	354	4*300
380	4	201	240	201	240	354	385	354	385	4*300
410	4	240	240	240	240	385	385	385	385	4*300
Extra Efficiency										
250	3	201	201	166	0	354	354	291	0	4*300
280	3	201	240	201	0	354	354	354	0	4*300
310	3	240	240	240	0	354	354	354	0	4*300
350	4	201	201	201	201	354	354	354	354	4*300
380	4	201	240	201	240	354	354	354	354	4*300
410	4	240	240	240	240	354	354	354	354	4*300
415	4	240	240	240	240	385	385	385	385	4*300
High Seasonal Efficiency										
250	3	188	201	153	0	188	354	153	0	4*300
280	3	188	240	188	0	188	354	188	0	4*300
310	3	224	240	224	0	224	354	224	0	4*300
350	4	188	201	188	201	188	354	188	354	4*300
380	4	188	240	188	240	188	354	188	354	4*300
410	4	224	240	224	240	224	354	224	354	4*300
450	4	238	240	238	240	238	354	238	354	4*300
High Seasonal Efficiency Short										
250	3	188	201	153	0	188	354	153	0	4*300
280	3	188	240	188	0	188	354	188	0	4*300
310	3	224	240	224	0	224	354	224	0	4*300
350	4	188	201	188	201	188	354	188	354	4*300
380	4	188	240	188	240	188	354	188	354	4*300
410	4	224	240	224	240	224	354	224	354	4*300

Notes:

4. Compressor Maximum Amps under 400V/3/50
5. compressor start up amps under 400V/3/50

Dimensional Data

The dimensional data below are given for reference only. Dimensions details, dimensions of hydraulic connections, electrical connections, isolator positioning, specific features for heat recovery and free cooling are included in submittals and diagrams provided in documentation package.

Figure 21 – Units RTAF 090 to 205 SE HE XE

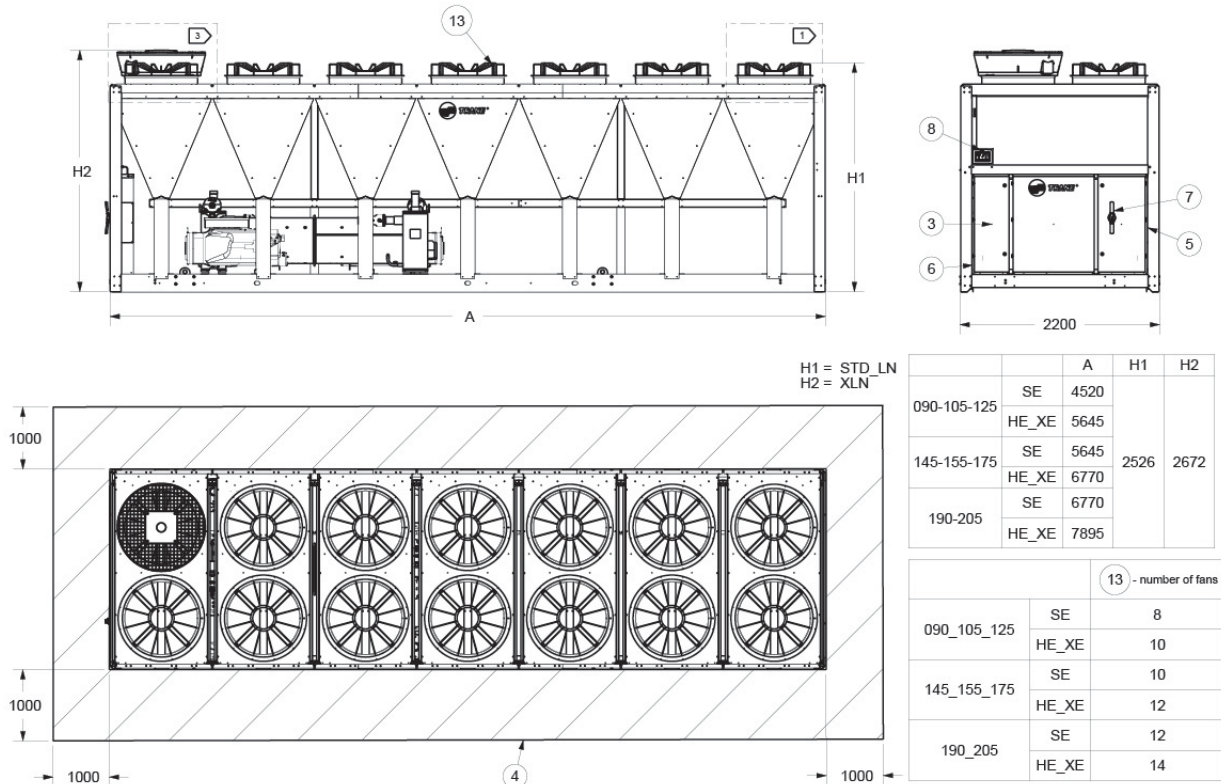

Operating weight (kg)									
		090	105	125	145	155	175	190	205
SN LN unit	SE	3295	3330	3510	3970	4240	4400	4820	4845
	HE_XE	3595	3630	3810	4220	4485	4640	5075	5210
Hydraulic module DPSP	SE	3645	3690	3910	4410	4780	4945	5365	5390
	HE_XE	3975	4020	4240	4660	5025	5180	5615	5750
Hydraulic module DPHP	SE	3730	3760	3955	4575	4840	4995	5420	5445
	HE_XE	4055	4090	4285	4820	5090	5240	5680	5810
XLN unit	SE	+80	+80	+80	+100	+100	+100	+120	+120
	XE	+100	+100	+100	+120	+120	+120	+140	+140
Hydraulic module VPF	SE-HE-XE	+70							

DPSP: Dual Pump Standard Pressure

DPHP: Dual Pump High Pressure

Important! Additional space is required to remove evaporator tubes.

For RTAF 090 to 245: 2.5 m in front of the unit (evaporator side).

Dimensional Data

Figure 22 – Units RTAF 090 to 245 HSE HSS

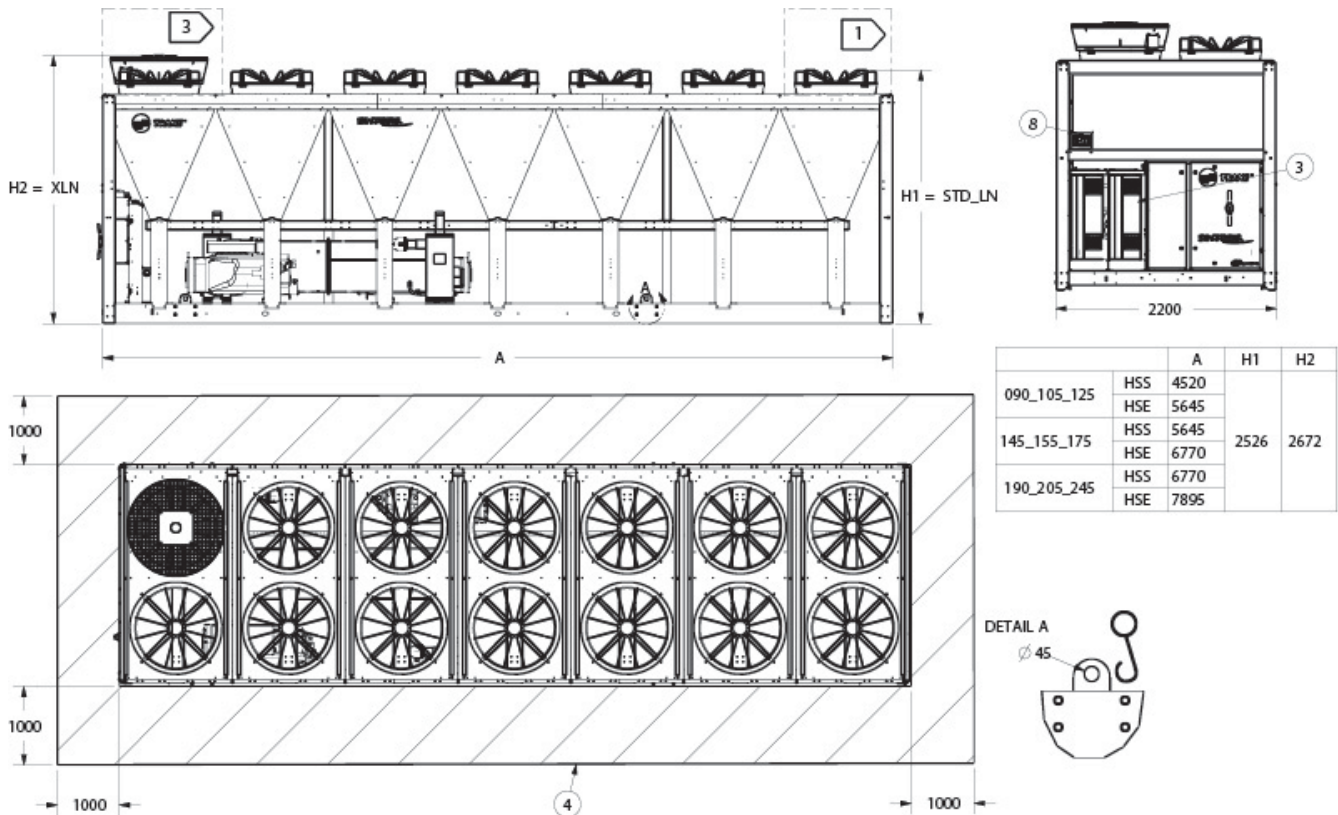

Operating weight (kg)										
		090	105	125	145	155	175	190	205	245
SN LN unit	HSS	3400	3435	3615	4075	4340	4610	5070	5100	5205
	HSE	3700	3735	3915	4320	4585	4850	5325	5460	5460
Hydraulic module DPSP	HSS	3750	3795	4015	4515	4885	5160	5620	5645	5755
	HSE	4080	4125	4345	4760	5125	5390	5865	6000	6000
Hydraulic module DPHP	HSS	3835	3865	4060	4680	4945	5210	5675	5700	5810
	HSE	4160	4195	4390	4925	5190	5450	5930	6060	6060
XLN unit	HSS	+ 80	+80	+80	+100	+100	+100	+120	+ 120	+120
	HSE	+ 100	+100	+100	+120	+120	+120	+140	+140	+140
Hydraulic module VPF		+70								

DPSP: Dual Pump Standard Pressure
 DPHP: Dual Pump High Pressure

Important! Additional space is required to remove evaporator tubes.
 For RTAF 090 to 245: 2.5 m in front of the unit (evaporator side).

Dimensional Data

Figure 23 – RTAF 250-410 SE HE XE

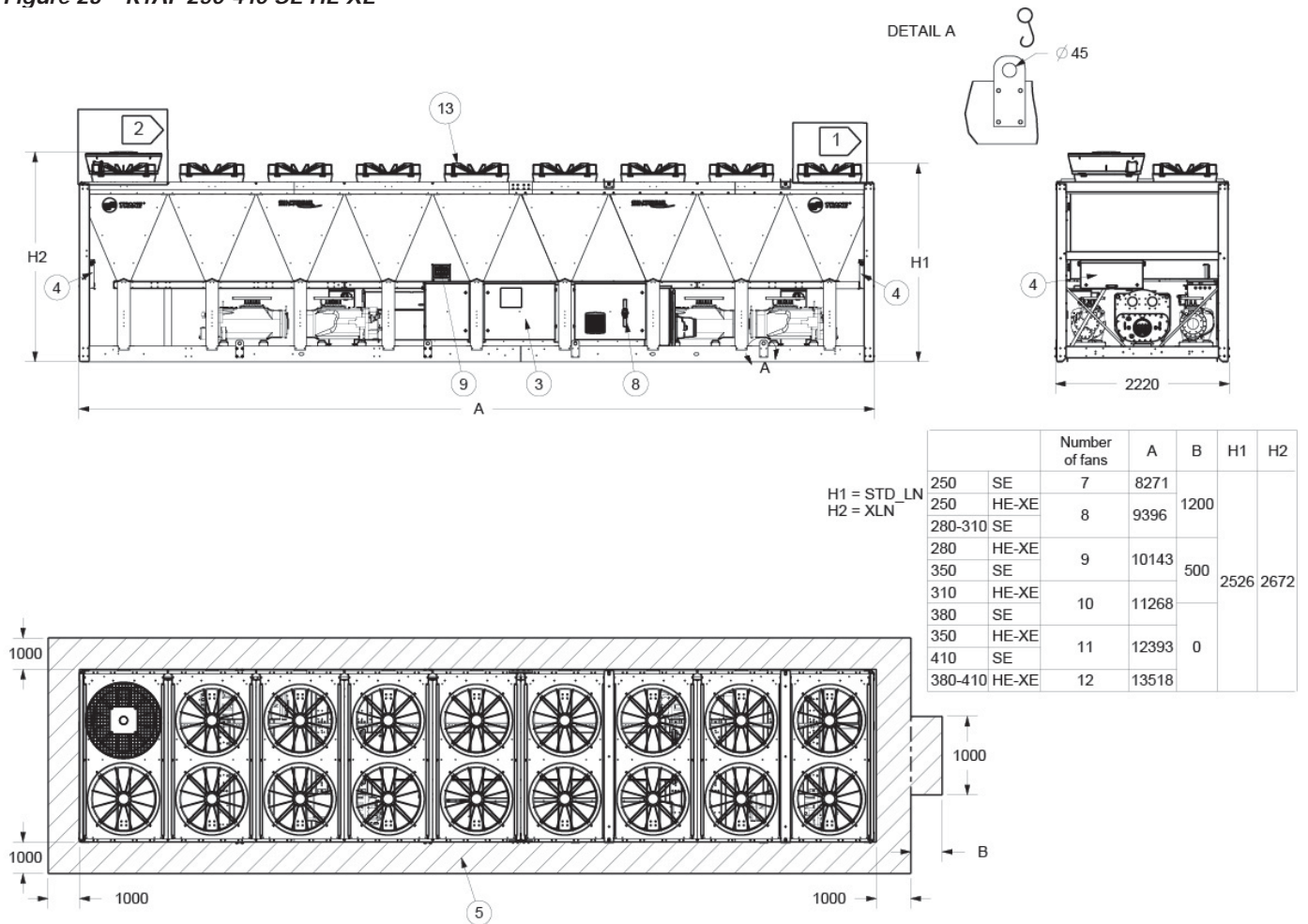

		Operating weight (kg)								
		250	280	310	350	380	410	450		
SN-LN unit	HSS	6685	7275	7325	8700	9070	9425	-----		
	HSE	7005	7575	7945	9345	9650	9715	9715		
Option XLN	HSS	+140	+160	+160	+180	+200	+220	-----		
	HSE	+160	+180	+200	+220	+240	+240	+240		
Hydraulic Module DPSP	HSS	7354	8264	8314	9929	10299	10654	-----		
	HSE	7678	8564	8934	10574	10879	10944	10944		
Hydraulic Module DPHP	HSS	7379	8053	8103	-----	-----	-----	-----		
	HSE	7703	8353	8103	-----	-----	-----	-----		
Hydraulic Module VPF	HSS_HSE								+70	

Important! Additional space is required to remove evaporator tubes.

For RTAF sizes 250 to 450 : 4.5 meter in front of the unit (evaporator outlet side at the right of the electrical panel).

Dimensional Data

Figure 24 – RTAF 250-450 HSS HSE

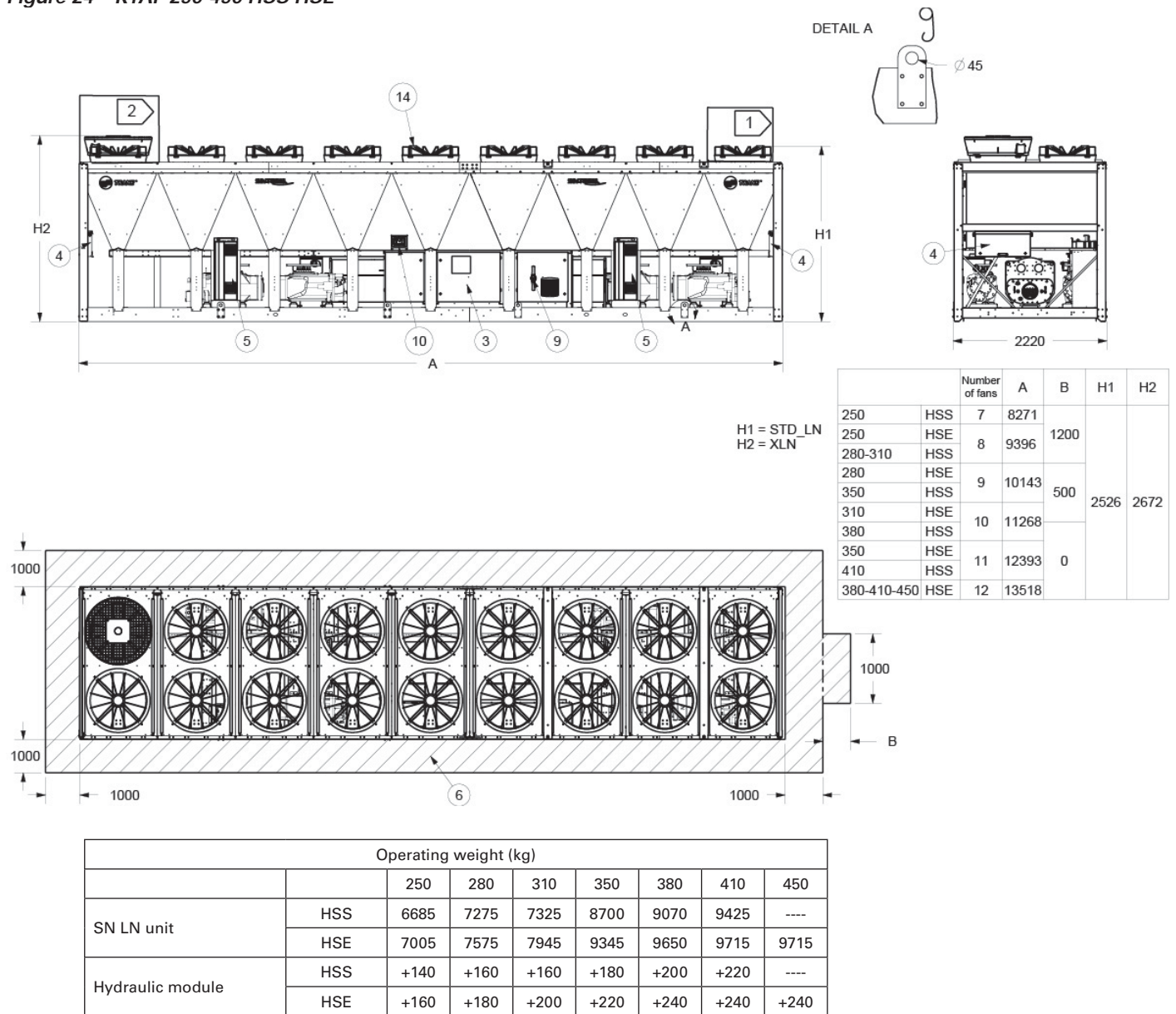

Important! Additional space is required to remove evaporator tubes.
 For RTAF sizes 250 to 450 : 4.5 meter in front of the unit (evaporator outlet side at the right of the electrical panel).

Mechanical Specifications

General

Chilled water production will be made by a factory-assembled and tested, air-cooled liquid chiller, Trane type RTAF SE/HE/XE/HSE/HSS. Chiller will have two refrigerant circuits with one compressor per circuit, will be shipped with a full operating charge of R134a refrigerant or R513A as an option and lubrication oil, screw compressors and electronic expansion valve.

Documentation including installation-operation-maintenance manual, user guide, wiring diagram and submittal is placed in the control panel.

Performances summary

- Cooling capacity at full load:.... (kW)
- Unit power input at full load:.....(kW)
- Operating conditions: Evaporator entering/leaving temperature:/.....(°C).
Air temperature:.....(°C).
- Energy efficiency at full load EER:..... (kW/kW)
- European Seasonal Energy Efficiency Ratio ESEER:..... (kW/kW)
- Sound power level:..... dB(A)

Quality assurance

Chiller is designed and manufactured under a quality assurance system and environmental management system certified in accordance with ISO 9001:2008 and ISO14001 standards.

Chiller is factory-tested according standard EN14511, and performances are certified by Eurovent. All chillers follow a production quality plan to ensure proper construction and operation.

Unit construction will be in accordance with follow European directives:

- Pressure Equipment Directive (PED) 97/23/CE
- Machinery Directive (MD) 2006/42/CE
- Low Voltage Directive (LV) 2006/95/CE
- ElectroMagnetic Compatibility Directive (EMC) 2004/108/CE
- Electrical Machinery Safety Standard EN 60204-1

Construction Characteristics

Unit panels, frames and exposed steel surfaces will be constructed of galvanized steel, painted and have a corrosion resistance of 675 hours to salt spray test.

Electrical panel will be built of galvanized steel and rated IP54.

Compressors and Motors

The helical-rotary compressor is semi-hermetic, direct drive, 3000 rpm, differential refrigerant pressure oil circulation system without oil pump, and with oil heater.

On Trane RTAF HSE Capacity control is done through the VFD to optimize performances at partial load allowing reduction of capacity down to 20% of the maximum value.

On Trane RTAF SE, HE and XE capacity control will be made through a slide valve allowing reduction of capacity down to 15% of the maximum value. Compressor will start always unloaded.

Motor is suction gas cooled, hermetically sealed, two poles, squirrel cage induction type, with four pressure lubricated rolling elements, bearing groups shall support the rotating assembly. Motor bearings will be designed for the whole life of the chiller.

Oil Management

The chiller is equipped with an oil management system without oil pump that ensures proper oil circulation throughout the unit. The key components of the system include an oil separator, oil filter with particles retention capacity of at least 5µm.

An oil heater is installed to avoid startup with low oil temperature.

An optional oil cooler is installed when the unit is used for high condensing temperature or low evaporator temperature conditions.

Unit-Mounted Wye-Delta Starter (RTAF SE, HE and XE)

The compressor starters shall be Star-Delta configuration closed transition, factory-mounted and fully pre-wired to the compressor motor and control panel. Starter will reduce by 33% the inrush current.

Adaptive Frequency Drive (AFD) mounted on RTAF HSE

Compressors of RTAF HSE shall be equipped with an adaptive frequency drive, factory mounted, tested and wired. Frequency converter will drive the chiller start and ramp up, and the partial load operation.

AFD enclosure is IP55 as standard, with integrated air cooling system, consisting of a fan below the VFD frame.

Evaporator

The evaporator is a tube-in-shell heat exchanger design constructed from carbon steel shells and tubesheets with internally and externally finned seamless copper tubes mechanically expanded into the tube sheets. Tubes are cleanable with dismountable water boxes. Tubes diameter is 19mm. Each tube is individually replaceable.

The evaporator is designed, tested and stamped in accordance with PED 97/23/CE Pressure Vessel Code for a refrigerant side working pressure of 14 bars (200 psig). The evaporator is designed for a water side working pressure of 10.5 bars (150 psig). Standard water connections are grooved for Victaulic type pipe couplings. Waterboxes are available in 2 passes configurations and include a vent, a drain and fittings for temperature control sensors. Evaporator is insulated with Armaflex II or equivalent of 19 mm (3/4 inches) thickness and K factor of 0,26 W/m²K.



Mechanical Specifications

Condenser and Fans

The air-cooled Microchannel condenser coils use all aluminum brazed fin construction. The coil is composed of three components: the flat microchannel tube, the fins located between the microchannel tubes, and two refrigerant manifolds. Coils can be cleaned with high pressure water.

The condenser coil has an integral subcooling circuit. The maximum allowable working pressure of the condenser is 25.0 bars. Condensers are factory proof and leak tested at 45 bars.

Direct-drive vertical-discharge airfoil condenser fans are dynamically balanced.

Standard units will start and operate from -10°C to 46°C (14°F to 115°F) ambient.

SE and HE units standard ambient or high ambient, standard sound level or low sound level are equipped with three-phase condenser fan motors with permanently lubricated ball bearings and external overload protection are provided. Fans are class F, IP55.

Standard units and HE units low ambient, XE and HSE units are equipped with EC condenser fan motors with permanently lubricated ball bearings and external overload protection are provided. Fans are class F, IP55.

Refrigerant Circuit

Each unit has two refrigerant circuits, with one rotary screw compressor per circuit. Each refrigerant circuit includes compressor discharge service valves, motorized suction valve, liquid line shut off valve, removable core filter, charging port, high pressure and low pressure safety valves and electronic expansion valve.

Electrical Panel

Single point connection with disconnect switch and fuses.

The disconnect switch is mechanically interlocked to disconnect line power from the starter before the starter doors are open.

All components and control cables are numbered in accordance with CEI 60750.

A factory-installed, factory-wired control power transformer provides all unit control power and UC800 module power. All the starter elements are enclosed in an IP54 panel, with hinged door.

Unit Controls (Tracer UC800)

The microprocessor-based control panel is factory-installed and factory-tested. The control system is powered by a control power transformer. It loads and unloads the chiller through adjustment of the compressor slide valve on models RTAF SE/HE and through a Adaptive Frequency Drive on the model RTAF HSE.

Microprocessor-based chilled water reset based on return water is standard. The UC800 utilizing the "Adaptive Control™" microprocessor automatically takes action to prevent unit shutdown due to abnormal operating conditions associated with low evaporator refrigerant temperature, high condensing temperature, and motor current overload. If abnormal operating condition continues and protective limit is reached, the refrigerant circuit will be shut down. Controller includes machine protection shutdown requiring manual reset for:

- Low evaporator refrigerant temperature and pressure
- High condenser refrigerant pressure
- Low oil flow
- Critical sensor or detection circuit fault
- Motor current overload
- High compressor discharge temperature
- Communications lost between modules
- Electrical distribution faults: phase loss, phase imbalance, phase reversal
- External and local emergency stop
- Starter transition failure.

The panel includes machine protection shutdown with automatic reset when the condition is corrected for:

- Momentary power loss
- Over / under voltage
- Loss of evaporator water flow.

Over 100 diagnostic checks is made and are displayed when a fault is detected. The display indicates the fault, the type of reset required, the time and date the diagnostic occurred, the mode in which the machine was operating at the time of the diagnostic, and a help message. A diagnostic history displays the last 20 diagnostics with the time and date of their occurrence. Alarms and diagnostics are displayed in chronological order, with a color/symbol code: red octagon for immediate shutdown, yellow triangle for normal shutdown and blue circle for warning.

Mechanical Specifications

Human interface with Touchable Display Trane TD7

- Factory-mounted above the control panel door
- UV Resistant touchscreen
- -40°C to 70°C operating temperature
- IP56 rated
- CE certification
- Emissions: EN55011(Class B)
- Immunity: EN61000 (Industrial)
- 7" diagonal
- 800x480 pixels
- TFT LCD @ 600 nits brightness
- 16 bit color graphic display

Display features:

- Alarms
- Reports
- Chiller settings
- Display settings
- Graphing
- Support for 15 languages

Dry contacts

UC800 provides a flexible alarm or chiller status indication to a remote location through a hard wired interface to a dry contact closure. Four relays are available for this function.

Options

Application options

Ice making

The ice making option provides special control logic to handle low temperature brine applications (less than 4.4°C (40°F) leaving evaporator temperature) for thermal storage applications.

Low temperature brine

Low temperature option provides special control logic and oil cooler is installed to handle low temperature brine applications including part load conditions below 4.4°C (40°F) leaving evaporator temperature.

Low ambient

The low ambient option adds unit controls to allow start and operation down to ambient temperatures of -20°C (-7.2°F). High side of ambient range remains at 46°C (115°F)

High ambient

The high ambient option adds unit controls, oil coolers and oversized electrical components to allow start and operation up to ambient temperatures of 55°C (131°F) operation. Low side of ambient range remains at -10°C (14°F).

Integrated Variable Primary Flow

Integrated within the chiller controller, a variable primary flow option will allow control of the water flow through the evaporator. This will be based on a proven algorithm modulating the flow rate to minimize pump consumption at full and partial load.

Two options of operating modes will be available:

Constant Differential Pressure (DP), acting continuously on the pump speed to ensure a constant outlet pressure. This solution is recommendable on installations with 2-way valves on the water coils. This method ensures that each branch of the water loop has an uniform supply, without unnecessary energy consumption. This system will ensure that each water terminal has the appropriate differential pressure supply. In order to manage chiller minimum evaporator water flow, a hydronic package will include water pressure transducers to intelligently monitor water flow rate in real time within AdaptiView™ chiller control. Chiller will deliver control signal for system by-pass valve actuator. System differential pressure is measured by supplied differential pressure transducer.

Constant Differential Temperature (DT), in this case the chiller controller algorithm will maintain a constant difference in between entering and leaving temperature at the chiller plant (DT), regardless the load, reducing the water flow rate when necessary up to the minimum allowed. This solution can be applied on water loops with 3-way valves systems, and can deliver higher energy saving than precedent logic (constant DP) in the majority of the comfort applications.

Partial Heat Recovery

Chiller can be supplied with a factory-mounted brazed plate heat exchanger, fitted in series or parallel with condenser refrigerant circuit (2), in order to fulfill heat recovery from the compressor discharge (de-superheat) and partially from the condensing saturated temperature. Heat to be recovered will be around 25% of the nominal cooling capacity for PHR and 135% of the nominal cooling capacity for THR.

For PHR, BPHX will be connected in series on water side, with temperature sensors in the water inlet and outlet, for monitoring purposes. The PHR HX will not have impact on the cooling performances, and will allow production of hot water up to 55°C.

For THR option BPHX will be placed parallel to condenser and a 3 way valve placed to turn ON/OFF THR. In THR only option temperature sensors and with THR Full option additionally a flow switch, water side 3 way valve and insulated water piping with heaters are included.

Free-cooling Control

Chiller controller could supply a control option for an externally supplied dry cooler to implement free-cooling strategy, allowing as per pre-fixed ambient temperature set point, switch from chiller operation to dry cooler operation. Control algorithm will be based on PID logic, return temperature and cooling capacity demand.

Mechanical Specifications

Free-cooling Chiller

Chiller can be supplied with option for water based free-cooling, built with all aluminum flat channel dry cooler exchanger, installed in parallel with refrigerant microchannel condenser coil, and a water valve to control the free-cooling capacity. Follow options shall be available:

- Total Direct Free-cooling
- Partial Direct Free-cooling
- Total Glycol free Free-cooling
- Partial Glycol free Free-cooling

E-coating

An option to supply MCHC condenser coils with e-coating will be available. This e-coating will withstand the exposure to typical corrosive atmospheres, in shore or industrial locations, without sensible impact on coil performances in what heat transfer and air pressure drop is a concern.

Sound level options

Low noise

Low noise units are equipped with a jacket on the oil separators and a pre-formed 'sound box' encapsulating each compressor.

Low noise with NNSB

Night noise set back allow to reduce the sound level of the chiller by reducing the speed of EC fans controlled with an external on/off contact.

Extra low noise

Extra low noise units are equipped with a jacket on the oil separators, a pre-formed 'sound box' encapsulating each compressor and EC fans with diffusers.

Hydraulic module option*

Hydraulic module includes the following components: water strainer, 80 l expansion vessel, pressure relief valve set at 5 bars, twin pump low head allowing a pressure drop in the water circuit up to 120 kPa or twin pump high head allowing a pressure drop in the water circuit up to 220 kPa, balancing valve and anti freeze protection.

Electrical options

- Under/over voltage protection
- IP20 internal protection
- Flow switch: the flow switch is sent as an accessory and must be installed on site.

Control options

BACnet™ communications interface

Allows the user to easily interface with BACnet via a single twisted pair wiring to a factory installed and tested communication board.

LonTalk™ (LCI-C) Communications Interface

Provides the LonMar chiller profile inputs/outputs for use with a generic building automation system via a single twisted pair wiring to a factory installed and tested communication board.

ModBus™ Communications Interface

Allows the user to easily interface with ModBus via a single twisted pair wiring to a factory installed and tested communication board.

External chilled water setpoint

UC800 accepts either a 2-10 VDC or a 4-20mA input signal, to adjust the chilled water setpoint from a remote location.

External current limit setpoint

UC800 accepts either a 2-10VDC or a 4-20mA input signal to adjust the current limit setpoint from a remote location.

Ice making contact

UC800 provides an output contact closure that can be used as a signal to the system that ice building is in operation. This relay will be closed when ice building is in progress and open when ice building has been terminated by either UC800 or the remote interlock. It is used to signal the system changes required to convert to and from ice making.

Run test report

Run test report gives the results of the performance test of the unit in the design conditions specified in the order write-up with water without glycol.

The data recorded are: cooling capacity, power input, air temperature, water entering temperature, water leaving temperature and water flow.

Mechanical Specifications

Other Options

Relief valves

Dual relief valve plus 3-way valve on high and low pressure side.

High performance insulation.

Evaporator is insulated with 2 layers of Armaflex II or equivalent of 19 mm (3/4 inches) thickness and K factor of 0,26 W/m²°K.

Evaporator without insulation

Evaporator is not insulated and a specific insulation can be done on site.

Coated condensing coils

Condensing coils are protected with a cathodic epoxy electrodeposition coating UV resistant

Neoprene pads

Neoprene pads avoids a direct contact of the base of the unit with the ground

Neoprene isolators

Isolators provide isolation between chiller and structure to help eliminate vibration transmission and have an efficiency of 95% minimum

Grooved pipe plus weld coupling

Grooved pipes are connected on water inlet and outlet. The coupling allows connection between the grooved pipe and the evaporator water connection.

Export shipping package

Metallic chocks are fixed on the base frame of the unit. They prevent direct contact between the chiller and the container during loading and unloading from the container.

* Components may differ depending on unit model and size. Contact your local sales office for details.



Trane optimizes the performance of homes and buildings around the world. A business of Ingersoll Rand, the leader in creating and sustaining safe, comfortable and energy efficient environments, Trane offers a broad portfolio of advanced controls and HVAC systems, comprehensive building services and parts. For more information visit www.Trane.com

Trane has a policy of continuous product and product data improvement and reserves the right to change design and specifications without notice.

© 2016 Trane All rights reserved

RLC-PRC046D-GB April 2016

Supersedes RLC-PRC046C-GB July 2015

We are committed to using environmentally
conscious print practices that reduce waste.

